

**V810™  
32-BIT MICROPROCESSOR**

The μPD70732 (a.k.a. V810) microprocessor is NEC's first microprocessor of the V810 family™ for embedded control applications.

The V810 employs a RISC architecture for embedded control applications. This product has high-speed real time response, high-speed integer operation instruction, bit string instruction, floating-point operation instruction, and significantly high cost performance is realized for applications such as facsimile, digital PPC, word processor, image processor, real time control device, etc.

**The functions are described in detail in the following User's Manuals, which should be read before starting design work.**

- **V805™, V810 User's Manual Hardware : U10661E**
- **V810 Family User's Manual Architecture : U10082E**

**Features**

- High-performance 32-bit architecture for embedded control application
  - 32-bit separate address/data bus
  - 1-Kbyte cache memory
  - Pipeline structure of 1 clock pitch
  - 16-bit fixed instructions (with some exceptions)
  - 32-bit general-purpose registers: 32
  - 4-Gbyte linear address space
  - Register/flag hazard interlocked by hardware
- Dynamic bus sizing function (16 bits)
- 16-bit bus fixing function  
16-bit bus system can be configured.
- Instructions ideal for various application fields
  - Floating-point operation instructions (based upon IEEE754 data format)
  - Bit string instructions
- 16 levels of high-speed interrupt responses
- Clock can be stopped by internal static operation
- Maximum operating frequency: 16/20/25 MHz
- Low voltage:  $V_{DD} = 2.7$  to 3.6 V (Max. 16 MHz)  
 $V_{DD} = 2.2$  to 3.6 V (Max. 10 MHz)
- Small package versions available (14 x 14 mm fine-pitch TQFP) ★

The information in this document is subject to change without notice.

Ordering Information

Part Number	Package	Max. operating freq. (MHz)
μPD70732GD-16-LBB	120-pin plastic QFP (28 x 28 mm)	16
μPD70732GD-20-LBB	120-pin plastic QFP (28 x 28 mm)	20
μPD70732GD-25-LBB	120-pin plastic QFP (28 x 28 mm)	25
★ μPD70732GC-25-9EV	120-pin plastic TQFP (Fine pitch) (14 x 14 mm)	25
μPD70732R-25	176-pin ceramic PGA (Seam weld)	25

Pin Outline

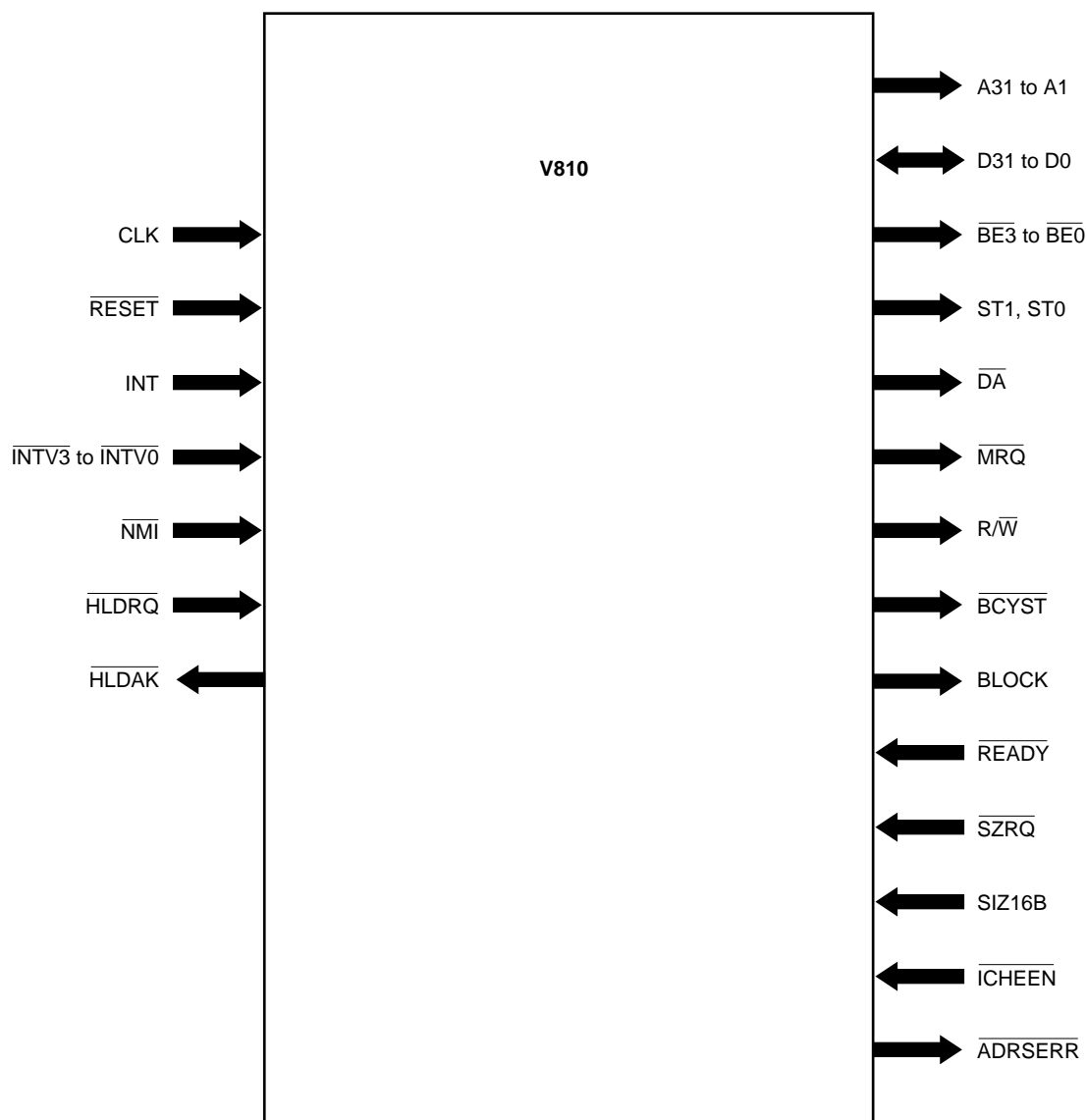

Pin Configuration

• 120-pin plastic QFP (28 x 28 mm) (Top View)

μPD70732GD-xx-LBB

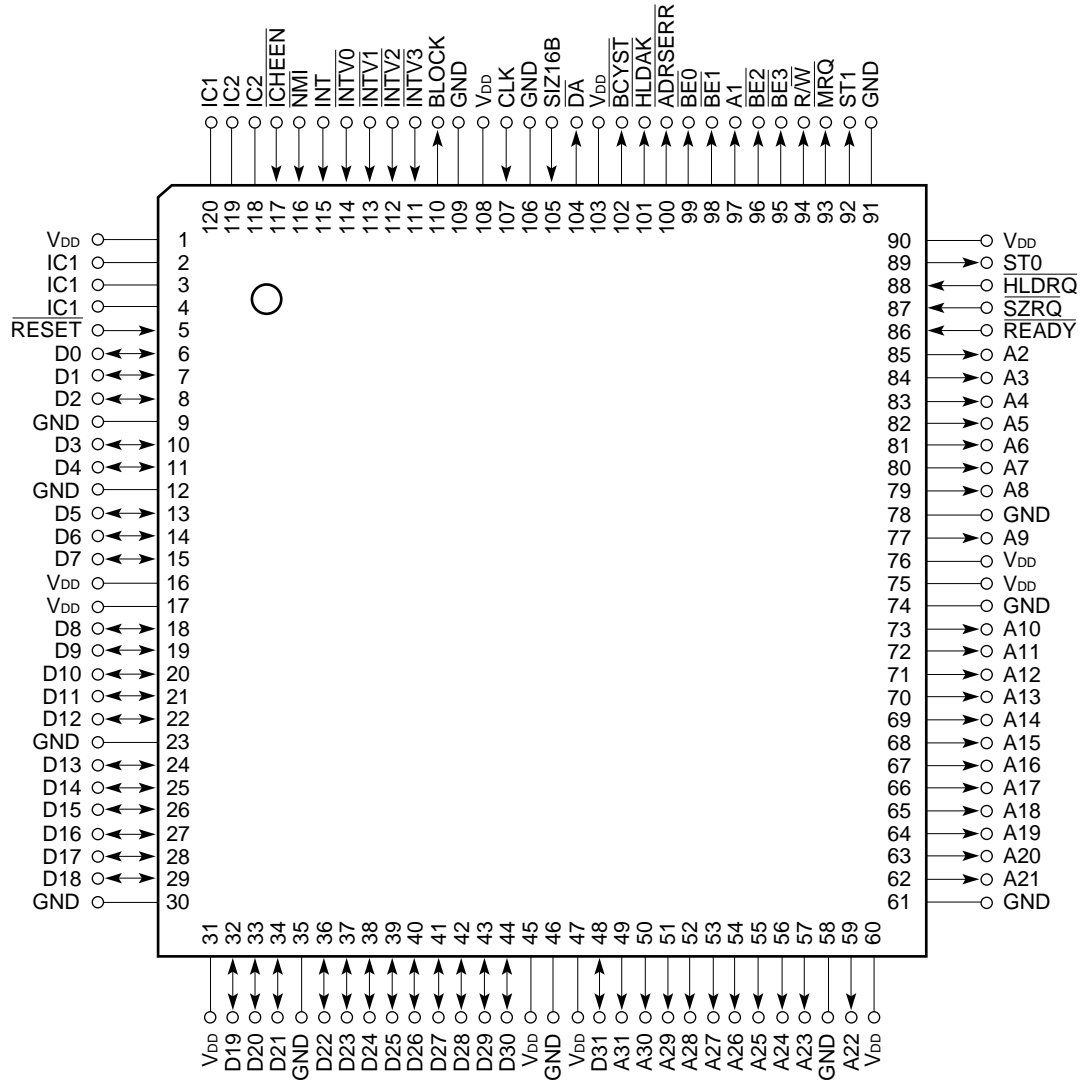

- Cautions**
1. Leave the IC1 pin open.
  2. Connect the IC2 pin to GND.

**Remark** IC: Internally Connected

- ★ • 120-pin plastic TQFP (Fine pitch) (14 x 14 mm) (Top View)  
μPD70732GC-25-9EV

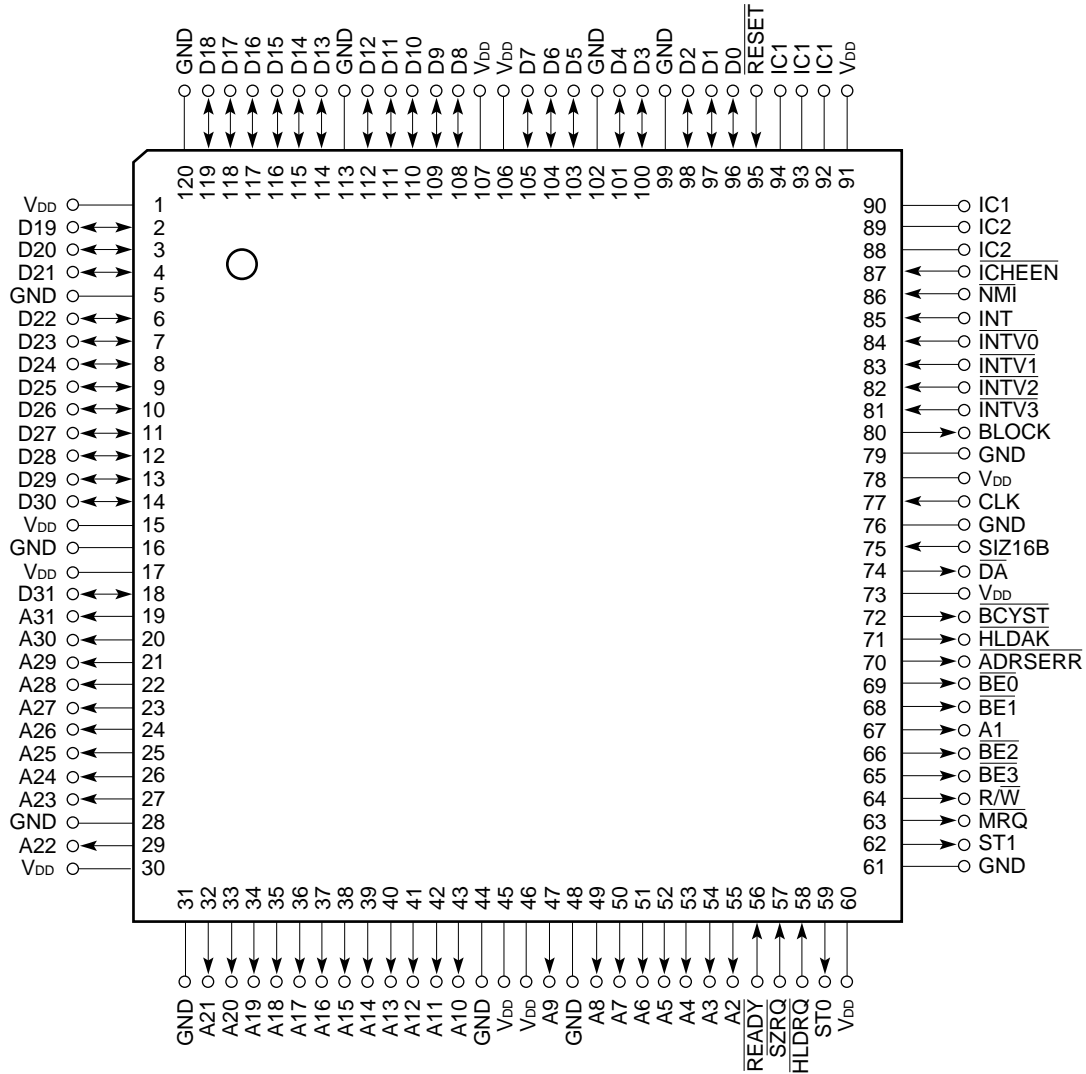

- Cautions**
1. V<sub>DD</sub> is power supply pin. All V<sub>DD</sub> pins should be connected to a +5V power supply (the same power supply).
  2. GND is ground pin. All GND pins should be connected to the same GND.
  3. Leave the IC1 pin open.
  4. Connect the IC2 pin to GND.

**Remark** IC: Internally Connected

- 176-pin ceramic PGA (Seam weld)  
μPD70732R-25

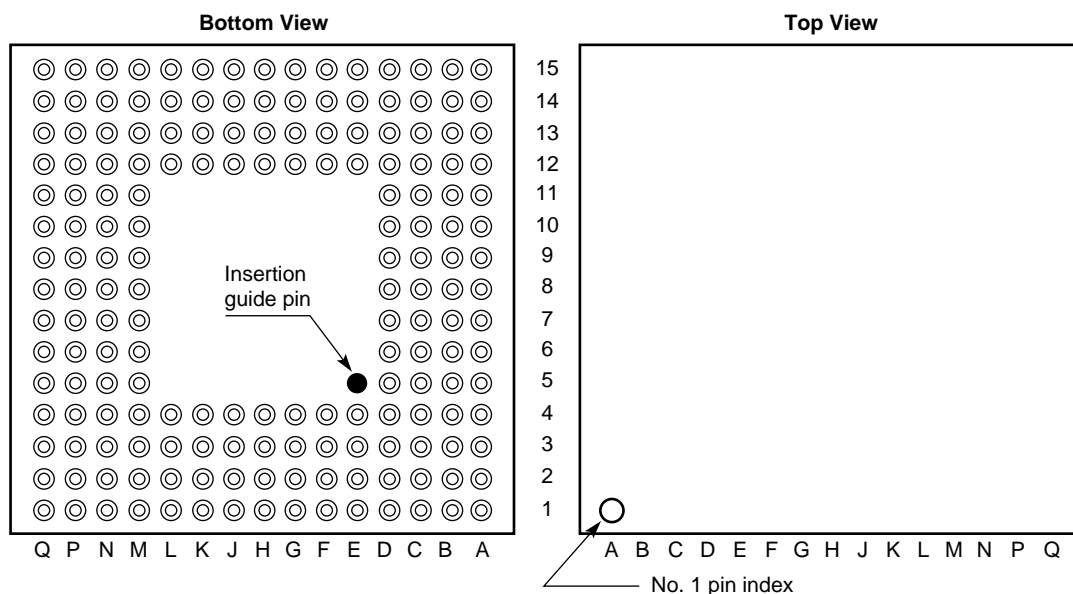

**Remark** The insertion guide pin is not included in the number of pins.

No.	Signal	No.	Signal	No.	Signal	No.	Signal
A1	IC2	B3	GND	C5	V <sub>DD</sub>	D7	V <sub>DD</sub>
A2	D12	B4	D11	C6	D8	D8	V <sub>DD</sub>
A3	D13	B5	GND	C7	V <sub>DD</sub>	D9	GND
A4	D10	B6	D7	C8	D4	D10	IC3
A5	GND	B7	V <sub>DD</sub>	C9	D2	D11	IC2
A6	D6	B8	D3	C10	IC3	D12	GND
A7	IC2	B9	GND	C11	V <sub>DD</sub>	D13	INT
A8	D5	B10	D0	C12	IC1	D14	$\overline{\text{INTV1}}$
A9	IC2	B11	GND	C13	IC2	D15	GND
A10	D1	B12	IC1	C14	V <sub>DD</sub>	E1	D27
A11	V <sub>DD</sub>	B13	GND	C15	$\overline{\text{NMI}}$	E2	D25
A12	$\overline{\text{RESET}}$	B14	IC1	D1	D23	E3	D21
A13	IC1	B15	$\overline{\text{ICHEEN}}$	D2	D22	E4	D19
A14	IC1	C1	V <sub>DD</sub>	D3	D20	E12	IC3
A15	IC2	C2	V <sub>DD</sub>	D4	GND	E13	$\overline{\text{INTV0}}$
B1	D17	C3	D16	D5	D15	E14	IC3
B2	D18	C4	D14	D6	D9	E15	IC1

No.	Signal	No.	Signal	No.	Signal	No.	Signal
F1	V <sub>DD</sub>	J4	V <sub>DD</sub>	M7	V <sub>DD</sub>	P4	A12
F2	D26	J12	IC2	M8	A5	P5	GND
F3	D24	J13	IC2	M9	V <sub>DD</sub>	P6	A8
F4	GND	J14	IC1	M10	ST1	P7	GND
F12	$\overline{\text{INTV2}}$	J15	IC1	M11	A1	P8	A6
F13	$\overline{\text{INTV3}}$	K1	IC2	M12	GND	P9	GND
F14	V <sub>DD</sub>	K2	A27	M13	$\overline{\text{BCYST}}$	P10	$\overline{\text{SZRQ}}$
F15	GND	K3	A25	M14	$\overline{\text{DA}}$	P11	GND
G1	D29	K4	A24	M15	SIZ16B	P12	$\overline{\text{MRQ}}$
G2	D28	K12	GND	N1	V <sub>DD</sub>	P13	GND
G3	IC2	K13	BLOCK	N2	V <sub>DD</sub>	P14	$\overline{\text{ADRSERR}}$
G4	IC2	K14	V <sub>DD</sub>	N3	A17	P15	$\overline{\text{BE0}}$
G12	V <sub>DD</sub>	K15	V <sub>DD</sub>	N4	A15	Q1	IC2
G13	IC2	L1	A28	N5	V <sub>DD</sub>	Q2	A13
G14	IC1	L2	A26	N6	A9	Q3	A14
G15	IC1	L3	A22	N7	V <sub>DD</sub>	Q4	A11
H1	A31	L4	A20	N8	V <sub>DD</sub>	Q5	GND
H2	D30	L12	$\overline{\text{HLDAK}}$	N9	A3	Q6	A7
H3	GND	L13	V <sub>DD</sub>	N10	$\overline{\text{HLDRQ}}$	Q7	IC2
H4	D31	L14	IC1	N11	V <sub>DD</sub>	Q8	A4
H12	GND	L15	IC1	N12	$\overline{\text{BE2}}$	Q9	IC2
H13	CLK	M1	GND	N13	$\overline{\text{BE1}}$	Q10	A2
H14	IC1	M2	A23	N14	V <sub>DD</sub>	Q11	$\overline{\text{READY}}$
H15	IC2	M3	A21	N15	IC1	Q12	ST0
J1	A30	M4	GND	P1	A18	Q13	$\overline{\text{BE3}}$
J2	A29	M5	A16	P2	A19	Q14	R/ $\overline{\text{W}}$
J3	IC2	M6	A10	P3	GND	Q15	IC2

- Cautions**
1. Leave the IC1 pin open.
  2. Connect the IC2 pin to GND.
  3. Connect the IC3 pin to power supply.

**Remark** IC: Internally Connected

## CONTENTS

1. PIN FUNCTIONS .....	8	
1.1 Pin Function List .....	8	
1.2 Pin I/O Circuits and Recommended Connection of Unused Pins .....	10	★
2. REGISTER SET .....	12	★
2.1 Program Register Set .....	13	
2.2 System Register Set .....	14	
3. DATA TYPES .....	15	★
3.1 Data Types .....	15	
3.1.1 Data type and addressing .....	15	
3.1.2 Integer .....	16	
3.1.3 Unsigned integer .....	16	
3.1.4 Bit string .....	16	
3.1.5 Single-precision floating-point data .....	17	
3.2 Data Alignment .....	17	
4. ADDRESS SPACE .....	18	★
5. BUS INTERFACE FUNCTION .....	21	★
6. INTERRUPT AND EXCEPTION .....	22	★
7. CACHE .....	23	★
8. RESET .....	24	★
9. INSTRUCTION SET .....	25	★
9.1 Instruction Format .....	25	
9.2 Instruction Mnemonic (in alphabetical order) .....	27	
10. ELECTRICAL SPECIFICATIONS .....	37	
10.1 Specifications When $V_{DD} = +5\text{ V} \pm 10\%$ .....	38	
10.2 Specifications When $V_{DD} = 2.7\text{ to }3.6\text{ V}$ .....	47	
10.3 Specifications When $V_{DD} = 2.2\text{ to }3.6\text{ V}$ .....	51	
11. PACKAGE DRAWINGS .....	59	
12. RECOMMENDED SOLDERING CONDITIONS .....	62	

## 1. PIN FUNCTIONS

### 1.1 Pin Function List

Name	I/O	Function	Bus hold status during operation	Bus hold status at reset	Bus idle status at reset
A31 to A1 (Address Bus)	3-state output	Address bus	Hi-Z	Hi-Z	H <sup>Note</sup>
D31 to D0 (Data Bus)	3-state I/O	Bidirectional data bus	Hi-Z	Hi-Z	Hi-Z
$\overline{BE}3$ to $\overline{BE}0$ (Byte Enable)	3-state output	Indicates valid data bus when data is accessed	Hi-Z	Hi-Z	H
ST1, ST0 (Status)	3-state output	Indicates type of bus cycle	Hi-Z	Hi-Z	H
$\overline{DA}$ (Data Access)	3-state output	Strobe signal for bus cycle	Hi-Z	Hi-Z	H
$\overline{MRQ}$ (Memory Request)	3-state output	Indicates memory access	Hi-Z	Hi-Z	H
$R/\overline{W}$ (Read/Write)	3-state output	Distinguishes between read access and write access	Hi-Z	Hi-Z	H
$\overline{BCYST}$ (Bus Cycle Start)	3-state output	Indicates start of bus cycle	Hi-Z	Hi-Z	H
$\overline{READY}$ (Ready)	Input	Extends bus cycle	—	—	—
$\overline{HLDRQ}$ (Hold Request)	Input	Requests bus mastership	—	—	—
$\overline{HLDAK}$ (Hold Acknowledge)	Output	Acknowledges $\overline{HLDRQ}$	L	L	H
$\overline{SZRQ}$ (Bus Sizing Request)	Input	Requests bus sizing	—	—	—
SIZ16B (Bus Size 16 Bit)	Input	Fixes external data bus width to 16 bits	—	—	—
BLOCK (Bus Lock)	Output	Requests to inhibit use of bus	L	L	L
$\overline{ICHEEN}$ (Instruction Cache Enable)	Input	Operates instruction cache	—	—	—
INT (Maskable Interrupt)	Input	Interrupt request	—	—	—
$\overline{INTV}3$ to $\overline{INTV}0$ (Interrupt Level)	Input	Interrupt level	—	—	—

**Note** A1 pin is “H” in the 16-bit bus fixed mode; otherwise, it is “L”.



Name	I/O	Function	Bus hold status during operation	Bus hold status at reset	Bus idle status at reset
$\overline{\text{NMI}}$ (Non-Maskable Interrupt)	Input	Non-maskable interrupt request	—	—	—
CLK	Input	CPU clock input	—	—	—
$\overline{\text{RESET}}$ (Reset)	Input	Resets internal status	—	—	—
$\overline{\text{ADRSERR}}$ (Address Error)	Output	Indicates that data alignment is illegal	Not affected	H	H
$V_{DD}$ (Power Supply)	—	Positive power supply	—	—	—
GND (Ground)	—	Ground potential (0 V)	—	—	—
IC1 (Internally Connected 1)	—	Internally connected (Leave this pin open.)	—	—	—
IC2 (Internally Connected 2)	—	Internally connected (Ground this pin.)	—	—	—
IC3 (Internally Connected 3)	—	Internally connected (Connect this pin to power supply.)	—	—	—

★ 1.2 Pin I/O Circuits and Recommended Connection of Unused Pins

The I/O circuit type of each pin and recommended connection of unused pins are shown in Table 1-1. Figure 1-1 shows the I/O circuit of each type.

Table 1-1. Pin I/O Circuit Types and Recommended Connection Method of Unused Pins

Pin	I/O Circuit Type	Recommended Connection Method
D31 to D0	5	Open
A31 to A1	4	
$\overline{\text{BE}}3$ to $\overline{\text{BE}}0$		
ST1, ST0		
$\overline{\text{DA}}$		
$\overline{\text{MRQ}}$		
$\overline{\text{R/W}}$		
$\overline{\text{BCYST}}$		
$\overline{\text{READY}}$		
$\overline{\text{HLDRQ}}$		Connect to $V_{DD}$ via resistor
$\overline{\text{HLDAK}}$	4	Open
$\overline{\text{SZRQ}}$	1	Connect to $V_{DD}$ via resistor
SIZ16B		Connect to GND via resistor
BLOCK	4	Open
$\overline{\text{ICHEEN}}$	1	Connect to $V_{DD}$ via resistor
INT		Connect to GND via resistor
$\overline{\text{INTV}}3$ to $\overline{\text{INTV}}0$		Connect to $V_{DD}$ via resistor
$\overline{\text{NMI}}$		
CLK		—
$\overline{\text{RESET}}$		
$\overline{\text{ADRSERR}}$	4	Open
IC1	—	
IC2	—	Connect to GND
IC3	—	Connect to $V_{DD}$

Figure 1-1. Pin I/O Circuit

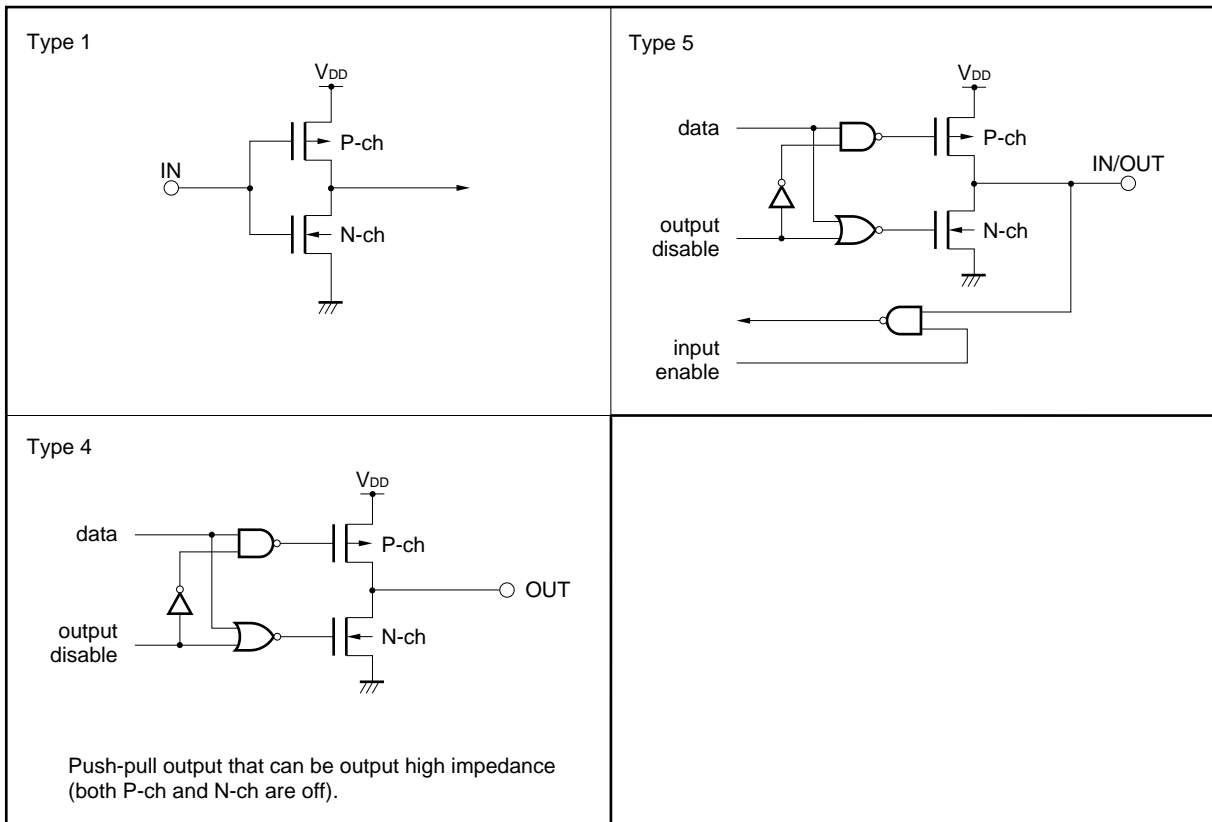

★ 2. REGISTER SET

The registers of the V810 can be classified into two types: general-purpose program register set and dedicated system register set. All registers are 32 bits wide.

**Program register sets**

31	0
r0	Zero Register
r1	Reserved for Address Generation
r2	Handler Stack Pointer (hp)
r3	Stack Pointer (sp)
r4	Global Pointer (gp)
r5	Text Pointer (tp)
r6	
r7	
r8	
r9	
r10	
r11	
r12	
r13	
r14	
r15	
r16	
r17	
r18	
r19	
r20	
r21	
r22	
r23	
r24	
r25	
r26	String Destination Bit Offset
r27	String Source Bit Offset
r28	String Length
r29	String Destination
r30	String Source
r31	Link Pointer (lp)

31	0
PC	Program Counter

**System register sets**

31	0
EIPC	Exception/Interrupt PC
EIPSW	Exception/Interrupt PSW

31	0
FEPC	Fatal Error PC
FEPSW	Fatal Error PSW

31	0
ECR	Exception Cause Register

31	0
PSW	Program Status Word

31	0
PIR	Processor ID Register

31	0
TKCW	Task Control Word

31	0
CHCW	Cache Control Word

31	0
ADTRE	Address Trap Register

**2.1 Program Register Set**

The program register set is composed of general-purpose registers and a program counter.

**(1) General-purpose registers**

Thirty-two general-purpose registers, r0 to r31, are available. All these registers can be used as data registers or address registers.

Of these registers, r0 and r26 through r30 are implicitly used by some instructions, and r1 through r5 and r31 are implicitly used by the assembler and C compiler. Therefore, when using these registers, it is necessary to take special care such as saving these registers' contents to different areas before using these registers and restoring the contents after using them.

**Table 2-1. Program Registers**

Register	Application	Operation
r0	Zero register	Always holds zeros.
r1	Register reserved for assembler	Used as a working register to generate a 32-bit immediate data.
r2	Handler stack pointer	Used as the stack pointer for the handler.
r3	Stack pointer	Used to generate a stack frame at a function call.
r4	Global pointer	Used to access a global variable in the data area.
r5	Text pointer	Points the start address of the text area.
r6 to r25	—	Stores address or data variables.
r26	String destination bit offset	Used in a bit-string instruction execution.
r27	String source bit offset	
r28	String length register	
r29	String destination address register	
r30	String address register	
r31	Link pointer	Stores the return address at execution of a JAL instruction.

**(2) Program Counter**

The program counter (PC) indicates the address of the instruction currently executed by the program. Bit 0 of the PC is fixed to 0, and execution cannot branch to an odd address. The contents of the PC are initialized to FFFFFFF0H at reset.

**2.2 System Register Set**

The system register set is composed of the following registers that perform operations such as CPU-status control and interrupt information holding.

**Table 2-2. System Register Number**

Number	Register Name	Application	Operation
0	EIPC	Status saving registers for exception/interrupt	The EIPC and EIPSW registers save the PC and PSW, respectively, when an exception or interrupt occurs. Because in the V810 the registers incorporated for this purpose are these registers only, save the contents of these registers by means of programming if your application set can cause multiple interrupt requests to be issued in the V810.
1	EIPSW		
2	FEPC	Status saving registers for NMI/duplexed exception	The FEPC and FEPSW registers save the PC and PSW, respectively, when an NMI or duplexed exception occurs.
3	FEPSW		
4	ECR	Exception cause register	This register, when an exception, maskable interrupt, or NMI occurs, holds its cause. This register consists of 32 bits. Its higher 16 bits, called FECC, hold the exception code for an NMI or duplexed exception, while the lower 16 bits, called EICC, hold the exception code for an exception or maskable interrupt.
5	PSW	Program status word	This register, also called the program status word, is a set of flags indicating the statuses of the CPU and program (instruction execution results).
6	PIR	Processor ID register	This register identifies the CPU type number.
7	TKCW	Task control word	This register controls floating-point operations.
8 to 23	Reserved		
24	CHCW	Cache control word	This register controls the on-chip instruction cache.
25	ADTRE	Address trap register	This register holds an address and is used for address trapping. When the address in this register matches the PC value, the execution jumps to a predefined address.
26 to 31	Reserved		

To read or write one of the registers shown above, specify a system register number with the system register load (LDSR) or system register store (STSR) instruction.

3. DATA TYPES ★

3.1 Data Types

The data types supported by the V810 are as follows:

- Integer (8, 16, 32 bits)
- Unsigned integer (8, 16, 32 bits)
- Bit string
- Single-precision floating-point data (32 bits)

3.1.1 Data type and addressing

The V810 uses the little-endian data addressing. In this addressing, if a fixed-length data is located in a memory area, the data must be either of the data types shown below.

(1) **Byte**

A byte is a consecutive 8-bit data whose first-bit address is aligned to a byte boundary. Each bit in a byte is numbered from 0 to 7: LSB (the least significant bit) is bit 0 and MSB (the most significant bit) is bit 7. To access a byte, specify address A. (See diagram below.)

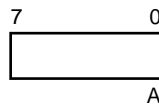

(2) **Halfword**

A halfword is a consecutive 16-bit (= 2 bytes) data whose first-bit address is aligned to a halfword boundary. Each bit in a halfword is numbered from 0 to 15: LSB (the least significant bit) is bit 0 and MSB (the most significant bit) is bit 15. To access a halfword, specify the address A only (lowest bit must be 0).

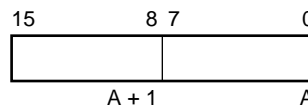

(3) **Word/short real**

A word, also called short real, is a consecutive 32-bit (= 4 bytes) data whose first-bit address is aligned to a word boundary. Each bit in a word is numbered from 0 to 31: LSB (the least significant bit) is bit 0 and MSB (the most significant bit) is bit 31. To access a word or short real, specify the address A only (lower two bits must be 0).

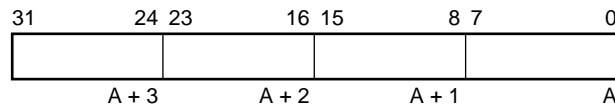

### 3.1.2 Integer

In the V810, all integers are expressed in the two's-complement binary notation, and are composed of either 8 bits, 16 bits, or 32 bits. Regardless of the data length, bit 0 is the least significant bit, and higher-numbered bits express higher digits of the integer with the highest bit expressing its sign.

Data Length		Range
Byte	8 bits	-128 to +127
Halfword	16 bits	-32768 to +32767
Word	32 bits	-2147483648 to +2147483647

### 3.1.3 Unsigned integer

An unsigned integer is either zero or a positive integer unlike the integer explained in section 3.1.2 which can be negative as well as zero and positive. Unsigned integers are expressed in the binary notation in the same way as integers, and are either 8 bits, 16 bits, or 32 bits long. Regardless of the data length, the bit assignments are the same as in the case of integers except that unsigned integers do not include a sign bit; the highest bit is also a part of the integer.

Data Length		Range
Byte	8 bits	0 to 255
Halfword	16 bits	0 to 65535
Word	32 bits	0 to 4294967295

### 3.1.4 Bit string

A bit string is a type of data whose bit length is variable from 0 to  $2^{32} - 1$ . To specify a bit-string data, define the following three attributes.

- A : address of the string data's first word (lower two bits must be 0.)
- B : in-word bit offset in the string data (0 to 31)
- M : bit length of the string data (0 to  $2^{32} - 1$ )

The above three attributes may vary depending on the bit-string data manipulation direction: upward or downward, as shown below. The former is the direction from lower addresses to higher addresses while the latter is the direction from higher to lower addresses.

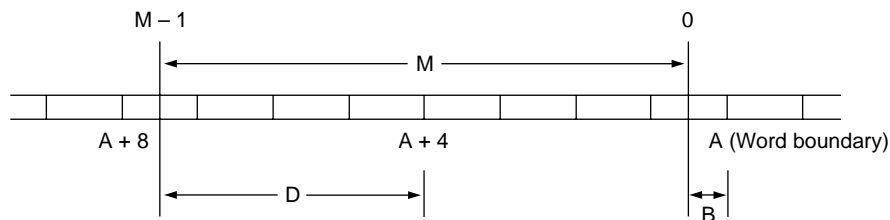

Attribute	Upward	Downward
First-word address (0s in bits 1 and 0)	A	A + 4
In-word bit offset (0 to 31)	B	D
Bit length (0 to $2^{32} - 1$ )	M	M



### 3.1.5 Single-precision floating-point data

This data type is 32 bits long and its bit allocation complies with the IEEE single format. A single-precision floating-point data consists of 1-bit mantissa sign bit, 8-bit exponent, and 23-bit mantissa. The exponent is offset-expressed from the bias value – 127, and the mantissa is binary-expressed with the integer part omitted.

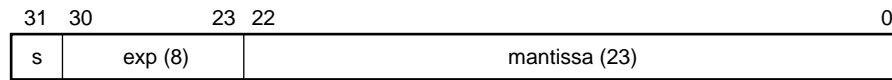

### 3.2 Data Alignment

In the V810, a word data must be aligned to a word boundary (with the lowest two bits of the address fixed to 0s), and a halfword data to a halfword boundary (with the lowest bit of the address fixed to 0). If a data is not aligned as specified, the lowest one bit (in the case of word) or two bits (in the case of halfword) of its address will forcibly be masked with 0s when the data is accessed.

★ 4. ADDRESS SPACE

The V810 supports 4 Gbytes of linear memory space and I/O space. The CPU outputs 32-bit addresses to the memory and I/Os; therefore, the addresses are from 0 to  $2^{32} - 1$ .

Bit number 0 of each byte data is defined as the LSB (Least Significant Bit), and bit number 7 is the MSB (Most Significant Bit). Unless otherwise specified, the byte data at the lower address side of data consisting of two or more bytes is the LSB, and the byte data at the higher address side is the MSB (little endian).

Data consisting of 2 bytes is called a halfword, and data consisting of 4 bytes is called a word. The lower address of memory or I/O data of two or more bytes, here, is shown on the right, and the higher address is shown on the left, as follows:

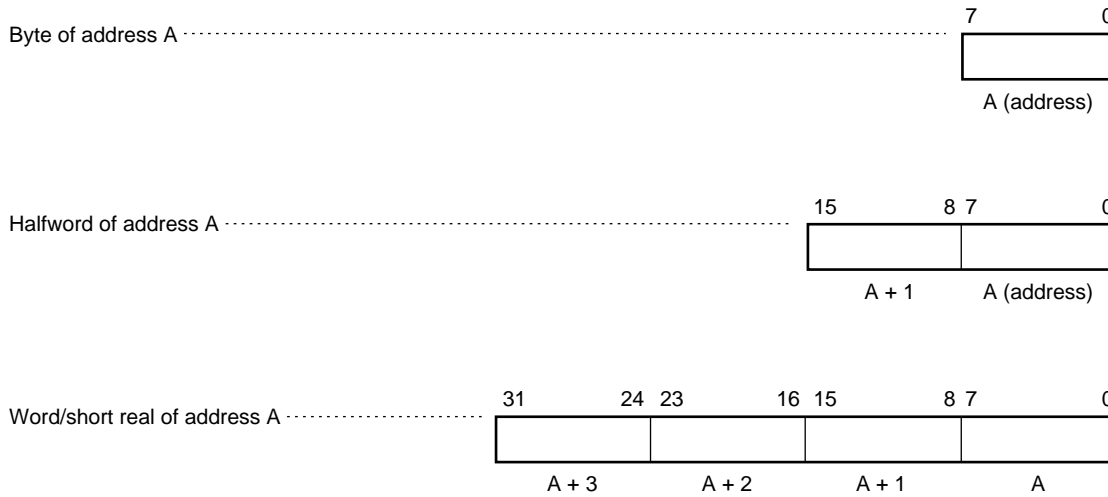
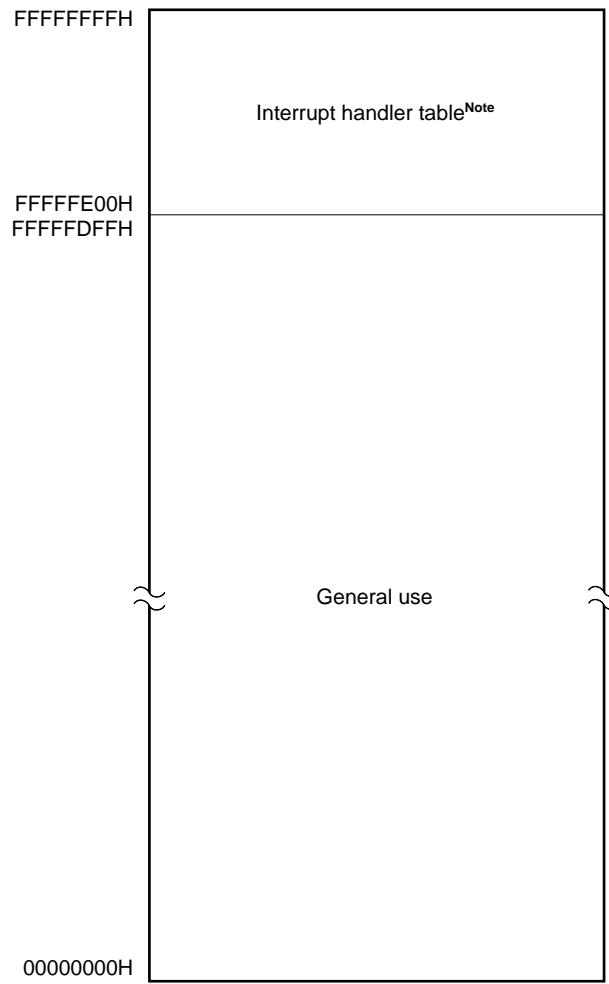

Figure 4-1 shows the memory map of the V810, and Figure 4-2 shows the I/O map.

**Figure 4-1. Memory Map**



**Note** For the details, refer to **Table 6-1 Exception Codes**.

Figure 4-2. I/O Map

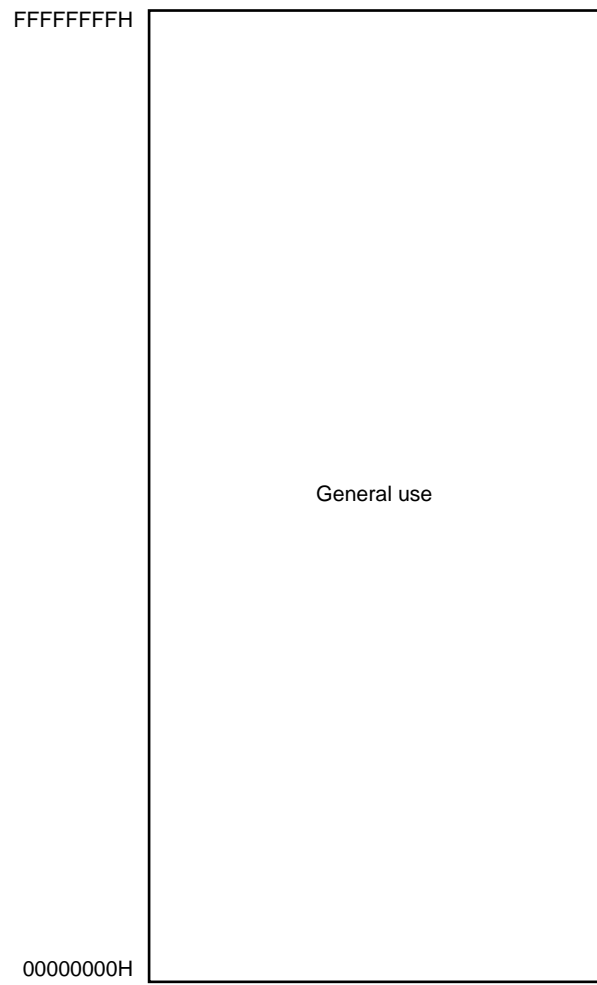

5. BUS INTERFACE FUNCTION



The V810 is equipped with a 32-bit data bus.

In the bus interface, there are two modes: 32-bit bus mode which uses the data bus in 32 bits and 16-bit bus fixed mode which fixes the bus in 16 bits. Modes can be switched only at reset using the SIZ16B signal.

The 32-bit bus mode has a dynamic bus sizing function which uses the data bus in 16-bit bus width to access the 16-bit peripherals. This function can be used by setting the  $\overline{\text{SZRQ}}$  signal active. Access to word data (32-bit data) in the dynamic bus sizing is executed by loading/storing a 16-bit data twice.

In the 16-bit bus fixed mode, access to word data (32-bit data) is executed by activating a bus cycle twice. The control signal and the A1 signal output values according to the 16-bit system.

The relationship between the external access and byte enable signals ( $\overline{\text{BE3}}$  to  $\overline{\text{BE0}}$ ) during the 32-bit bus mode and the 16-bit bus fixed mode is shown below.

**Table 5-1. Relationship among Address, Data Length, Byte Enable Signals and A1 (32-bit bus mode)**

Data length	Operand address		Byte enable				A1	Bus cycle sequence
	Bit 1	Bit 0	$\overline{\text{BE3}}$	$\overline{\text{BE2}}$	$\overline{\text{BE1}}$	$\overline{\text{BE0}}$		
Byte	0	0	1	1	1	0	0	1
	0	1	1	1	0	1	0	1
	1	0	1	0	1	1	0	1
	1	1	0	1	1	1	0	1
Halfword	0	0	1	1	0	0	0	1
	1	0	0	0	1	1	0	1
Word	0	0	0	0	0	0	0	1
			0	0	1	1	1	1

**Note** Bus cycle added by dynamic bus sizing

**Table 5-2. Relationship among Address, Data Length, Byte Enable Signals and A1 (16-bit bus fixed mode)**

Data length	Operand address		Byte enable				A1	Bus cycle sequence
	Bit 1	Bit 0	$\overline{\text{BE3}}$	$\overline{\text{BE2}}$	$\overline{\text{BE1}}$	$\overline{\text{BE0}}$		
Byte	0	0	Hi-Z	Hi-Z	1	0	0	1
	0	1	Hi-Z	Hi-Z	0	1	0	1
	1	0	Hi-Z	Hi-Z	1	0	1	1
	1	1	Hi-Z	Hi-Z	0	1	1	1
Halfword	0	0	Hi-Z	Hi-Z	0	0	0	1
	1	0	Hi-Z	Hi-Z	0	0	1	1
Word	0	0	Hi-Z	Hi-Z	0	0	0	1
			Hi-Z	Hi-Z	0	0	1	<sup>2</sup> Note

**Note** Added bus cycle

★ 6. INTERRUPT AND EXCEPTION

Interrupts are events that take place independently of the program execution and can be classified into maskable interrupts and a non-maskable interrupt. An exception is an event that takes place depending upon the program execution. There is little difference between the interrupt and exception in terms of flow, but the interrupt takes precedence over the exception.

The V810 architecture is provided with the interrupts and exceptions listed in the table below. If an exception, a maskable interrupt or NMI occurs, control is transferred to a handler whose address is determined by the source of the interrupt or exception. The exception source can be checked by examining an exception code stored in the ECR (Exception Code Register). Each handler analyzes the contents of the ECR and performs appropriate exception/interrupt servicing.

**Table 6-1. Exception Codes**

Exception and interrupt	Classification	Exception code	Handler address	Restore PC <sup>Note 1</sup>
Reset	Interrupt	F F F 0	F F F F F F F 0	<b>Note 2</b>
NMI	Interrupt	F F D 0	F F F F F F D 0	next PC <sup>Note 3</sup>
Duplexed exception	Exception	<b>Note 4</b>	F F F F F F D 0	current PC
Address trap	Exception	F F C 0	F F F F F F C 0	current PC
Trap instruction (parameter is 0x1n)	Exception	F F B n	F F F F F F B 0	next PC
Trap instruction (parameter is 0x0n)	Exception	F F A n	F F F F F F A 0	next PC
Invalid instruction code	Exception	F F 9 0	F F F F F F 9 0	current PC
Zero division	Exception	F F 8 0	F F F F F F 8 0	current PC
FIV (floating-point invalid operation)	Exception	F F 7 0	F F F F F F 6 0	current PC
FZD (floating-point zero division)	Exception	F F 6 8	F F F F F F 6 0	current PC
FOV (floating-point overflow)	Exception	F F 6 4	F F F F F F 6 0	current PC
FUD (floating-point underflow) <sup>Note 5</sup>	Exception	F F 6 2	F F F F F F 6 0	current PC
FPR (floating-point precision degradation) <sup>Note 5</sup>	Exception	F F 6 1	F F F F F F 6 0	current PC
FRO (floating-point reserved operand)	Exception	F F 6 0	F F F F F F 6 0	current PC
INT level n (n = 0 to 15)	Interrupt	F E n 0	F F F F F E n 0	next PC <sup>Note 3</sup>

- Notes**
1. PC to be saved to EIPC or FEPC.
  2. EIPC and FEPC are undefined.
  3. While an instruction whose execution is aborted by an interrupt (DIV/DIVU, single-precision floating-point data, bit string instruction) is executed, restore PC = current PC.
  4. The exception code of the exception that occurs for the first time is stored to the lower 16 bits of the ECR, and that of the second exception is stored in the higher 16 bits.
  5. In the V810, the floating-point underflow exception and floating-point precision degradation exception do not occur.

7. CACHE



Figure 7-1 shows the instruction cache configuration provided to the V810.

Figure 7-1. Cache Configuration

Capacity	: 1 Kbytes
Mapping system	: direct map
Block size	: 8 bytes
Sub-block size	: 4 bytes

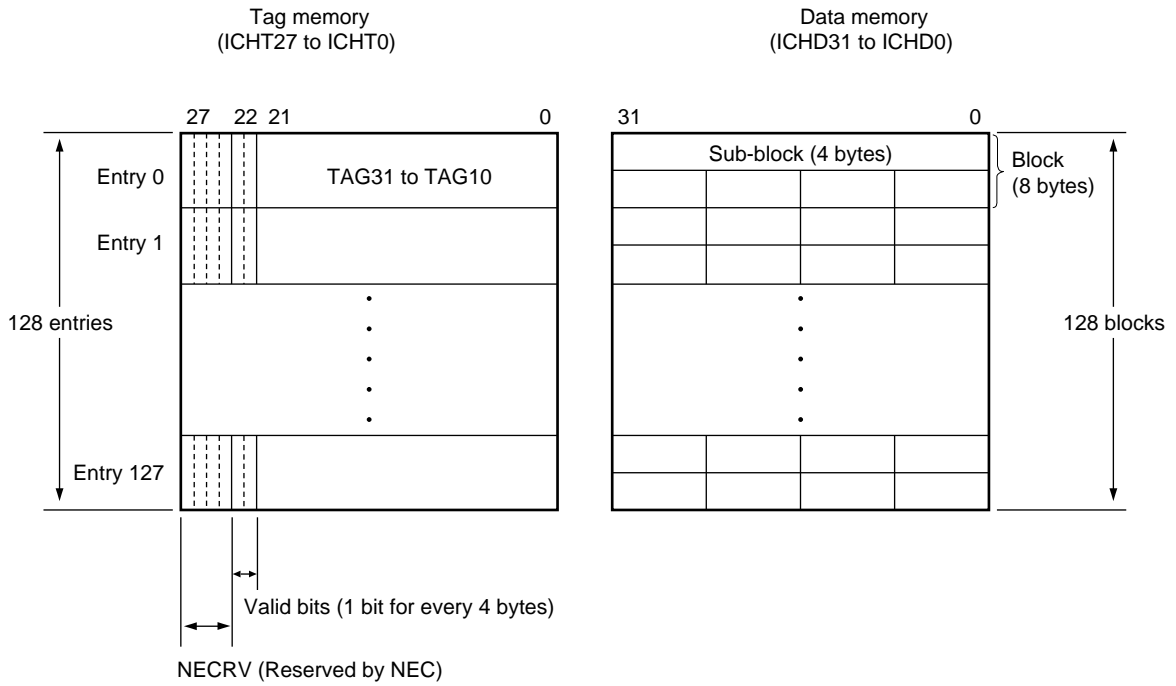
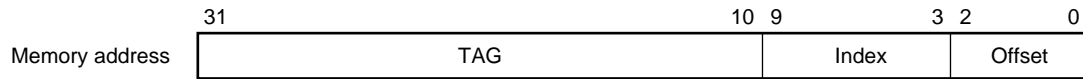

★ 8. RESET

A low-level input detection on the  $\overline{\text{RESET}}$  pin always triggers a system reset. Consequently, all the hardware-controlling registers are initialized as shown in Table 8-1. After the initialization procedure is completed and the  $\overline{\text{RESET}}$  pin returns to the high level, the device is released from the resetting state and starts the implementation of a program. Then, if necessary, set some registers to user-desired values in the first stage of the program.

**Table 8-1. Register State after Reset**

Hardware (Symbol)		State after Reset
Program counter	PC	FFFFFF0H
Status saving register for interrupt	EIPC	Undefind
	EIPSW	
Status saving register for NMI	FEPC	Undefind
	FEPSW	
Interrupt cause register	FECC	0000H
	EICC	FFF0H
Program status word	PSW	00008000H
General-purpose register	r0	Fixed to 00000000H
	r1 to r31	Undefind



9. INSTRUCTION SET



9.1 Instruction Format

The V810 instructions are formatted in either 16 bits or 32 bits. Examples of the 16-bit format instruction are binomial operation, control, and conditional branch; those for the 32-bit format are load/store, I/O manipulate, 16-bit immediate, jump & link, and extended operations.

Some instructions have an unused field. However, do not write a program that uses this field because it is reserved for future use. This unused field must be set to zeros.

Instructions are stored in memory in the following manner.

- The lower half of an instruction, that is, the half which includes bit 0, is stored at the lower address.
- The higher half of an instruction, that is, the half which includes bit 15 or 31, is stored at the higher address.

(1) reg-reg instruction format (Format I)

This format consists of one 6-bit field to hold an operation code and two 5-bit fields to specify general-purpose registers as instruction's operands. 16-bit instructions use this format.

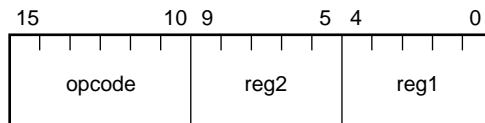

(2) imm-reg instruction format (Format II)

This format consists of one 6-bit field to hold an operation code, one 5-bit field to hold an immediate data, and one field to specify a general-purpose register as an operand. 16-bit instructions use this format.

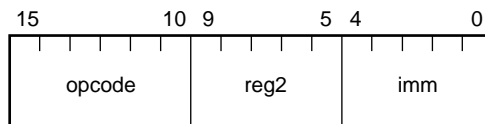

(3) Conditional branch instruction format (Format III)

This format consists of one 3-bit field to hold an operation code, one 4-bit field to hold a condition code, and one 9-bit field to hold a branch displacement (with its LSB masked to 0). 16-bit instructions use this format.

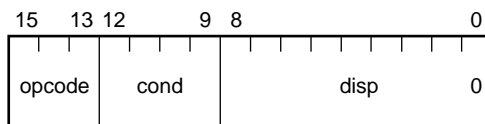

**(4) Intermediate jump instruction format (Format IV)**

This format consists of one 6-bit field to hold an operation code and one 26-bit field to hold a displacement (with its LSB masked to 0). 32-bit instructions use this format.

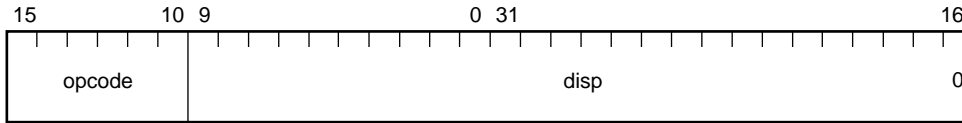

**(5) 3-operand instruction format (Format V)**

This format consists of one 6-bit field to hold an operation code, two fields to specify general-purpose registers as operands, and one 16-bit field to hold an immediate data. 32-bit instructions use this format.

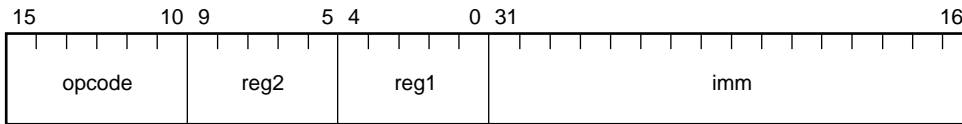

**(6) Load/store instruction format (Format VI)**

This format consists of one 6-bit field to hold an operation code, two fields to specify a general-purpose register, and one 16-bit field to hold a displacement. 32-bit instructions use this format.

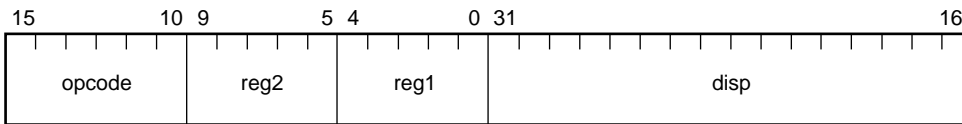

**(7) Extension instruction format (Format VII)**

This format consists of one 6-bit field to hold an operation code, two 5-bit fields to specify general-purpose registers as operands, and one 6-bit field to hold a sub-operation code. The remaining 10 bits are reserved for future use and must be set to zeros. 32-bit instructions use this format.

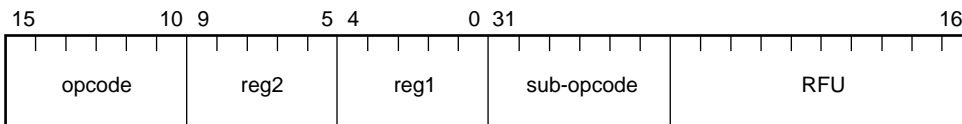

**9.2 Instruction Mnemonic (in alphabetical order)**

The list of mnemonics is shown below.

This section lists the instructions incorporated in the V810 along with their operations. The instructions are listed in the instruction mnemonic's alphabetical order to allow users to use this section as a quick reference or dictionary. The conventions used in the list are shown below.

Instruction Mnemonic	Operand (s)	Format	CY	OV	S	Z	Instruction Function
----------------------	-------------	--------	----	----	---	---	----------------------

**Legend**

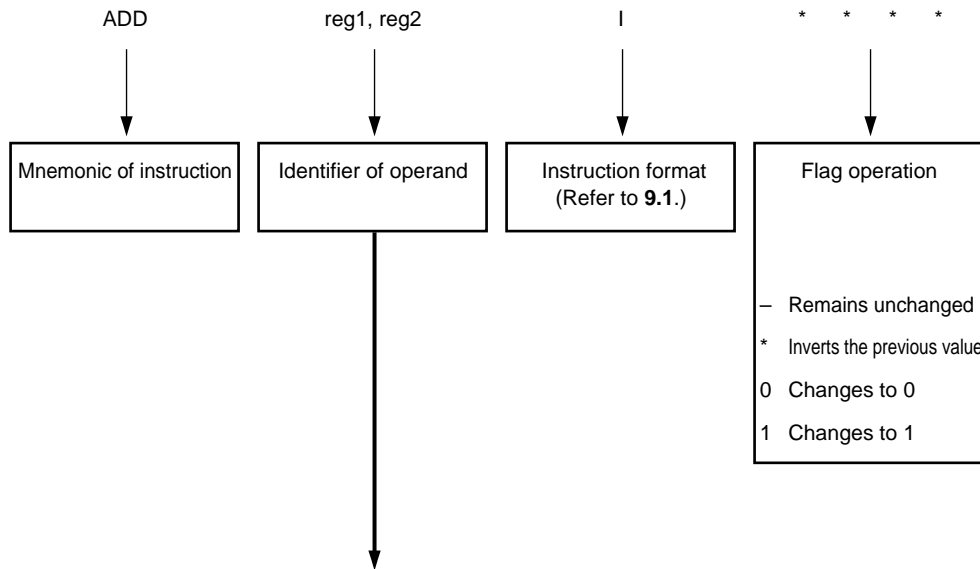

Identifier	Description
reg1	General-purpose register (Used as a source register)
reg2	General-purpose register (Used mainly as a destination register and occasionally as a source register)
imm5	5-bit immediate
imm16	16-bit immediate
disp9	9-bit displacement
disp16	16-bit displacement
disp26	26-bit displacement
regID	System register number
vector adr	Trap handler address that corresponds to a trap vector

Table 9-1. Instruction Mnemonics (in alphabetical order) (1/9)

Instruction Mnemonic	Operand (s)	Format	CY	OV	S	Z	Instruction Function
ADD	reg1, reg2	I	*	*	*	*	Addition: Adds the word data in the reg2-specified register and the word data in the reg1-specified register, then stores the result into the reg2-specified register.
ADD	imm5, reg2	II	*	*	*	*	Addition: Sign-extends the 5-bit immediate data to 32 bits, and adds the extended immediate data and the word data in the reg2-specified register, then stores the result into the reg2-specified register.
ADDF.S	reg1, reg2	VII	*	0	*	*	Floating-point addition: Adds the single-precision floating-point data in the reg2-specified register and the single-precision floating-point data in the reg1-specified register, then restores the result into the reg2-specified register while changing flags according to the result.
ADDI	imm16, reg1, reg2	V	*	*	*	*	Addition: Sign-extends the 16-bit immediate data to 32 bits, and adds the extended immediate data and the word data in the reg1-specified register, then stores the result into the reg2-specified register.
AND	reg1, reg2	I	-	0	*	*	AND: Performs the logical AND operation on the word data in the reg2-specified register and the word data in the reg1-specified register, then stores the result into the reg2-specified register.
ANDBSU	-	II	-	-	-	-	Transfer after ANDing bit strings: Performs a logical AND operation on a source bit string and a destination bit string, then transfers the result to the destination bit string.
ANDI	imm16, reg1, reg2	V	-	0	0	*	AND: Sign-extends the 16-bit immediate data to 32 bits, and performs a logical AND operation on the extended immediate data and the word data in the reg1-specified register, then stores the result into the reg2-specified register.
ANDNBSU	-	II	-	-	-	-	Transfer after NOTting a bit string then ANDing it with another bit string: Performs a logical AND operation on a destination bit string and the 1's complement of a source bit string, then transfers the result to the destination bit string.
BC	disp9	III	-	-	-	-	Conditional branch (if Carry): PC relative branch
BE	disp9	III	-	-	-	-	Conditional branch (if Equal): PC relative branch
BGE	disp9	III	-	-	-	-	Conditional branch (if Greater than or Equal): PC relative branch
BGT	disp9	III	-	-	-	-	Conditional branch (if Greater than): PC relative branch

**Table 9-1. Instruction Mnemonics (in alphabetical order) (2/9)**

Instruction Mnemonic	Operand (s)	Format	CY	OV	S	Z	Instruction Function
BH	disp9	III	-	-	-	-	Conditional branch (if Higher): PC relative branch
BL	disp9	III	-	-	-	-	Conditional branch (if Lower): PC relative branch
BLE	disp9	III	-	-	-	-	Conditional branch (if Less than or Equal): PC relative branch
BLT	disp9	III	-	-	-	-	Conditional branch (if Less than): PC relative branch
BN	disp9	III	-	-	-	-	Conditional branch (if Negative): PC relative branch
BNC	disp9	III	-	-	-	-	Conditional branch (if Not Carry): PC relative branch
BNE	disp9	III	-	-	-	-	Conditional branch (if Not Equal): PC relative branch
BNH	disp9	III	-	-	-	-	Conditional branch (if Not Higher): PC relative branch
BNL	disp9	III	-	-	-	-	Conditional branch (if Not Lower): PC relative branch
BNV	disp9	III	-	-	-	-	Conditional branch (if Not Overflow): PC relative branch
BNZ	disp9	III	-	-	-	-	Conditional branch (if Not Zero): PC relative branch
BP	disp9	III	-	-	-	-	Conditional branch (if Positive): PC relative branch
BR	disp9	III	-	-	-	-	Unconditional branch: PC relative branch
BV	disp9	III	-	-	-	-	Conditional branch (if Overflow): PC relative branch
BZ	disp9	III	-	-	-	-	Conditional branch (if Zero): PC relative branch
CAXI	disp16 [reg1], reg2	VI	*	*	*	*	Inter-processor synchronization in a multi-processor system.
CMP	reg1, reg2	I	*	*	*	*	Comparison: Subtracts the word data in the reg1-specified register from that for reg2 for comparison, then changes flags according to the result.
CMP	imm5, reg2	II	*	*	*	*	Comparison: Sign-extends the 5-bit immediate data to 32 bits, and subtracts the extended immediate data from the word data in the reg2-specified register for comparison, then changes flags according to the result.
CMPF.S	reg1, reg2	VII	*	0	*	*	Floating-point comparison: Subtracts the single-precision floating-point data in the reg1-specified register from that for reg2 for comparison, then changes flags according to the result.

Table 9-1. Instruction Mnemonics (in alphabetical order) (3/9)

Instruction Mnemonic	Operand (s)	Format	CY	OV	S	Z	Instruction Function
CVT.SW	reg1, reg2	VII	–	0	*	*	Data conversion from floating-point to integer: Converts the single-precision floating-point data in the reg1-specified register into an integer data, then stores the result into the reg2-specified register while changing flags according to the result.
CVT.WS	reg1, reg2	VII	*	0	*	*	Data conversion from integer to floating-point: Converts the integer data in the reg1-specified register into a single-precision floating-point data, then stores the result into the reg2-specified register while changing flags according to the result.
DIV	reg1, reg2	I	–	*	*	*	Signed division: Divides the word data in the reg2-specified register by that for reg1 with their sign bits validated, then stores the quotient into the reg2-specified register and the remainder into r30. Division is performed so that the sign of the remainder matches that of the dividend.
DIVF.S	reg1, reg2	VII	*	0	*	*	Floating-point division: Divides the single-precision floating-point data in the reg2-specified register by that for reg1, then stores the result into the reg2-specified register while changing flags according to the result.
DIVU	reg1, reg2	I	–	0	*	*	Unsigned division: Divides the word data in the reg2-specified register by that for reg1 with their data handled as unsigned data, then stores the quotient into the reg2-specified register and the remainder into r30. Division is performed so that the sign of the remainder matches that of the dividend.
HALT	–	II	–	–	–	–	Processor stop
IN.B	disp16 [reg1], reg2	VI	–	–	–	–	Port input: Sign-extends the 16-bit displacement to 32 bits, and adds the extended displacement and the content of the reg1-specified register to generate a 32-bit unsigned port address, then reads the byte data located at the generated port address, zero-extends the byte data to 32 bits, and stores the result into the reg2-specified register.
IN.H	disp16 [reg1], reg2	VI	–	–	–	–	Port input: Sign-extends the 16-bit displacement to 32 bits, and adds the extended displacement and the content of the reg1-specified register to generate a 32-bit unsigned port address, then reads the halfword data located at the generated port address while masking the address's bit 0 to 0, zero-extends the halfword data to 32 bits, and stores the result into the reg2-specified register.

**Table 9-1. Instruction Mnemonics (in alphabetical order) (4/9)**

Instruction Mnemonic	Operand (s)	Format	CY	OV	S	Z	Instruction Function
IN.W	disp16 [reg1], reg2	VI	-	-	-	-	Port input: Sign-extends the 16-bit displacement to 32 bits, and adds the extended displacement and the content of the reg1-specified register to generate a 32-bit unsigned port address, then reads the word data located at the generated address while masking the address's bits 0 and 1 to 0, and stores the word into the reg2-specified register.
JAL	disp26	IV	-	-	-	-	Jump and link: Increments the current PC by 4, then saves it into r31, and sign-extends the 26-bit displacement to 32 bits while masking the displacement's bit 0 to 0, adds the extended displacement and the PC value, loads the PC with the addition result, so that the instruction stored at the PC-pointing address is executed next.
JMP	[reg1]	I	-	-	-	-	Register-indirect unconditional branch: Loads the PC with the jump address value in the reg1-specified register while masking the value's bit 0 to 0, so that the instruction stored at the address pointed by the reg1-specified register is executed next.
JR	disp26	IV	-	-	-	-	Unconditional branch: Sign-extends the 26-bit displacement to 32 bits while masking bit 0 to 0, adds the result with the current PC value, and loads the PC with the addition result so that the instruction stored at the PC-pointing address is executed next.
LD.B	disp16 [reg1], reg2	VI	-	-	-	-	Byte load: Sign-extends the 16-bit displacement to 32 bits, and adds the result with the content of the reg1-specified register to generate the 32-bit unsigned address, then reads the byte data located at the generated address, sign-extends the byte data to 32 bits, and stores the result into the reg2-specified register.
LD.H	disp16 [reg1], reg2	VI	-	-	-	-	Halfword load: Sign-extends the 16-bit displacement to 32 bits, and adds the result with the content of the reg1-specified register to generate a 32-bit unsigned address while masking its bit 0 to 0, then reads the halfword data located at the generated address, sign-extends the halfword data to 32 bits, and stores the result into the reg2-specified register.
LD.W	disp16 [reg1], reg2	VI	-	-	-	-	Word load: Sign-extends the 16-bit displacement to 32 bits and adds the result with the content of the reg1-specified register to generate a 32-bit unsigned address while masking bits 0 and 1 to 0, then reads the word data located at the generated address and stores the data into the reg2-specified register.

Table 9-1. Instruction Mnemonics (in alphabetical order) (5/9)

Instruction Mnemonic	Operand (s)	Format	CY	OV	S	Z	Instruction Function
LDSR	reg2, regID	II	*	*	*	*	Loading system register: Transfers the word data in the reg2-specified register to the system register specified with the system register number (regID).
MOV	reg1, reg2	I	-	-	-	-	Transferring data: Loads the reg2-specified register with the word data in of the reg1-specified register.
MOV	imm5, reg2	II	-	-	-	-	Transferring data: Sign-extends the 5-bit immediate data to 32 bits, then loads the reg2-specified register with the extended immediate data.
MOVBSU	-	II	-	-	-	-	Transferring bit strings: Loads the destination bit string with the source bit string.
MOVEA	imm16, reg1, reg2	V	-	-	-	-	Addition: Sign-extends the 16-bit immediate data to 32 bits, adds it with the word data in the reg1-specified register, then stores the addition result into reg2.
MOVHI	imm16, reg1, reg2	V	-	-	-	-	Addition: Appends 16-bit zeros below the 16-bit immediate data to form a 32-bit word data, then adds it with the word data in the reg1-specified register, and stores the result into the reg2-specified register.
MUL	reg1, reg2	I	-	*	*	*	Signed multiplication: Signed-multiplies the word data in the reg2-specified register by that for reg1, then separates the 64-bit (double-word) result into two 32-bit data, and stores the higher 32 bits into r30 and the lower 32 bits into the reg2-specified register.
MULF.S	reg1, reg2	VII	*	0	*	*	Floating-point multiplication: Multiplies the single-precision floating-point data in the reg2-specified register by that for reg1, then stores the result into the reg2-specified register while changing flags according to the result.
MULU	reg1, reg2	I	-	*	*	*	Unsigned multiplication: Multiplies the word data in the reg2-specified register by that for reg1 while handling these data as unsigned data, then separates the 64-bit (double-word) result into two 32-bit data, and stores the higher 32 bits into r30 and the lower 32 bits into the reg2-specified register.
NOP	-	III	-	-	-	-	No operation: Makes no changes or operations while spending one instruction cycle.
NOT	reg1, reg2	I	-	0	*	*	Logical NOT: Obtains the 1's complement (logical NOT) of the content of the reg1-specified register, then stores the result into the reg2-specified register.



**Table 9-1. Instruction Mnemonics (in alphabetical order) (6/9)**

Instruction Mnemonic	Operand (s)	Format	CY	OV	S	Z	Instruction Function
NOTBSU	–	II	–	–	–	–	Transfer after NOTting a bit string: Obtains the 1's complement (all bits inverted) of the source bit string, then transfers the result to the destination bit string.
OR	reg1, reg2	I	–	0	*	*	OR: Performs a logical OR operation on the word data in the reg2-specified register and that for reg1, then stores the result into the reg2-specified register.
ORBSU	–	II	–	–	–	–	Transfer after ORing bit strings: Performs a logical OR operation on the source and destination bit strings, then transfers the result to the destination bit string.
ORI	imm16, reg1, reg2	V	–	0	*	*	OR: Zero-extends the 16-bit immediate data to 32 bits, performs a logical OR operation on the extended data and the word data in the reg1-specified register, then stores the result into the reg2-specified register.
ORNBSU	–	II	–	–	–	–	Transfer after NOTting a bit string and ORing it with another bit string: Obtains the 1's complement (logical NOT) of the source bit string, performs a logical OR operation on the NOTted bit string and the destination bit string, then transfers the result to the destination bit string.
OUT.B	reg2, disp16 [reg1]	VI	–	–	–	–	Port output: Sign-extends the 16-bit displacement to 32 bits, adds the extended value and the content of the reg1-specified register to generate a 32-bit unsigned port address, then outputs the lowest 8 bits (= 1 byte) of the reg2-specified register onto the port pins corresponding to the generated port address.
OUT.H	reg2, disp16 [reg1]	VI	–	–	–	–	Port output: Sign-extends the 16-bit displacement to 32 bits, adds the extended value and the content of the reg1-specified register to generate a 32-bit unsigned port address with its bit 0 masked to 0, then outputs the lowest 16 bits (= 1 halfword) of the reg2-specified register onto the port pins corresponding to the generated port address.
OUT.W	reg2, disp16 [reg1]	VI	–	–	–	–	Port output: Sign-extends the 16-bit displacement to 32 bits, adds the extended value and the content of the reg1-specified register to generate a 32-bit unsigned port address with its bits 0 and 1 masked to 0, then outputs the 32 bits (= 1 word) of the reg2-specified register onto the port pins corresponding to the generated port address.

Table 9-1. Instruction Mnemonics (in alphabetical order) (7/9)

Instruction Mnemonic	Operand (s)	Format	CY	OV	S	Z	Instruction Function
RETI	–	II	*	*	*	*	Return from a trap or interrupt routine: Reads the restore PC and PSW from the system registers and loads them to the due places to return from a trap or interrupt routine to the original operation flow.
SAR	reg1, reg2	I	*	0	*	*	Arithmetic right shift: Shifts every bit of the word data in the reg2-specified register to the right by the number of times specified with the reg1-specified register's lowest 5 bits, then stores the result into the reg2-specified register. In arithmetic right shift operations, the MSB is loaded with the LSB value at each shift.
SAR	imm5, reg2	II	*	0	*	*	Arithmetic right shift: Zero-extends the 5-bit immediate data to 32 bits, shifts every bit of the word data in the reg2-specified register to the right by the number of times specified with the extended immediate data, then stores the result into the reg2-specified register. In arithmetic right shift operations, the MSB is loaded with the LSB value at each shift.
SCH0BSU	–	II	–	–	–	*	Searching 0s in a bit string:
SCH0BSD	–	II	–	–	–	*	Searches "0" bits in the source bit string, and loads r30 and r27 with the address of the bit next to the first detected "0" bit, then r29 with the number of bits skipped until the first "0" bit is detected, and r28 with the value subtracted by the r29 value.
SCH1BSU	–	II	–	–	–	–	Searching 1s in a bit string:
SCH1BSD	–	II	–	–	–	–	Searches 1s in the source bit string, and loads r30 and r27 with the bit address next to the first detected "1" bit, then r29 with the number of bits skipped until the first "1" is detected, and r28 with the value subtracted by the r29 value.
SETF	imm5, reg2	II	–	–	–	–	Flag condition setting: Sets the reg2-specified register to 1 if the condition flag value matches the lowest 4 bits of the 5-bit immediate data, and sets the reg2-specified register to 0 when they do not match.
SHL	reg1, reg2	I	*	0	*	*	Logical left shift: Shifts every bit of the word data in the reg2-specified register to the left by the number of times specified with the reg1-specified register's lowest 5 bits, then stores the result into the reg2-specified register. In logical left shift operations, the LSB is loaded with 0 at each shift.

Table 9-1. Instruction Mnemonics (in alphabetical order) (8/9)

Instruction Mnemonic	Operand (s)	Format	CY	OV	S	Z	Instruction Function
SHL	imm5, reg2	II	*	0	*	*	Logical left shift: Zero-extends the 5-bit immediate data to 32 bits, shifts every bit of the word data in the reg2-specified register to the left by the number of times specified by the extended immediate data, then stores the result into the reg2-specified register. In logical left shift operations, the LSB is loaded with 0 at each shift.
SHR	reg1, reg2	I	*	0	*	*	Logical right shift: Shifts every bit of the word data in the reg2-specified register to the right by the number of times specified with the reg1-specified register's lowest 5 bits, then stores the result into the reg2-specified register. In logical right shift operations, the MSB is loaded with 0 at each shift.
SHR	imm5, reg2	II	*	0	*	*	Logical right shift: Zero-extends the 5-bit immediate data to 32 bits, shifts every bit of the word data in the reg2-specified register to the right by the number of times specified by the extended immediate data, then stores the result into the reg2-specified register. In logical right shift operations, the MSB is loaded with 0 at each shift.
ST.B	reg2, disp16 [reg1]	VI	-	-	-	-	Byte store: Sign-extends the 16-bit displacement to 32 bits and adds the 32-bit displacement and the content of the reg1-specified register to generate a 32-bit unsigned address, then transfers the reg2-specified register's lowest 8 bits to the generated address.
ST.H	reg2, disp16 [reg1]	VI	-	-	-	-	Halfword store: Sign-extends the 16-bit displacement to 32 bits with its bit 0 masked to 0, and adds the content of the reg1-specified register and the 32-bit displacement to generate a 32-bit unsigned address, then transfers the reg2-specified register's lower 16 bits to the generated address.
ST.W	reg2, disp16 [reg1]	VI	-	-	-	-	Word store: Sign-extends the 16-bit displacement to 32 bits with its bits 0 and 1 masked to 0, and adds the reg1-specified register and the 32-bit displacement to generate a 32-bit unsigned address, then transfers the content of the reg1-specified register to the generated address.
STSR	regID, reg2	II	-	-	-	-	Storing system register contents: Loads the reg2-specified register with the content of the system register specified by the system register number (regID).
SUB	reg1, reg2	I	*	*	*	*	Subtraction: Subtracts the content of the reg1-specified register from the content of the reg2-specified register, then stores the result into the reg2-specified register.

Table 9-1. Instruction Mnemonics (in alphabetical order) (9/9)

Instruction Mnemonic	Operand (s)	Format	CY	OV	S	Z	Instruction Function
SUBF.S	reg1, reg2	VII	*	0	*	*	Floating-point subtraction: Subtracts the single-precision floating-point data in the reg1-specified register from that for reg2, then stores the result into the reg2-specified register while changing flags according to the result.
TRAP	vector	II	-	-	-	-	Software trap: Jumps to a trap handler address according to the vector-specified trap vector (from 0 to 31) to start an exception handling after completing all necessary saving and presetting procedures as follows: (1) Saving the restore PC and PSW into the FEPC and FEPSW system registers, respectively, if the PSW's EP flag = 1, or into the EIPC and EIPSW system registers, respectively, if EP = 0 (2) Setting an exception code into the ECR's FECC and FESW flags if the PSW's EP flag = 1, or into the ECR's EICC if EP = 0 (3) Setting the PSW's ID flag and clearing the PSW's AE flag (4) Setting the PSW's NP flag if the PSW's EP flag = 1, or setting the PSW's ID flag if EP = 0
TRNC.SW	reg1, reg2	VII	-	0	*	*	Conversion from floating-point data to integer: Converts the single-precision floating-point data in the reg1-specified register into an integer data, then stores the result into the reg2-specified register while changing flags according to the result.
XOR	reg1, reg2	I	-	0	*	*	Exclusive OR: Performs a logical exclusive-OR operation on the word data in the reg2-specified register and that for reg1, then stores the result into the reg2-specified register.
XORBSU	-	II	-	-	-	-	Transfer of exclusive ORed bit string: Performs a logical exclusive-OR operation on the source and destination bit strings, then transfers the result to the destination bit string.
XORI	imm16, reg1, reg2	V	-	0	*	*	Exclusive OR: Zero-extends the 16-bit immediate data to 32 bits and performs a logical exclusive-OR operation on the extended immediate data and the word data in the reg2-specified register, then stores the result into the reg2-specified register.
XORNBSU	-	II	-	-	-	-	Transfer after exclusive-ORing a NOTted bit string and another bit string: Obtains the 1's complement (NOT) of the source bit string, and exclusive-ORs it with the destination bit string, then transfers the result to the destination bit string.

10. ELECTRICAL SPECIFICATIONS

Supported Electrical Specifications

Operating Supply Voltage	Operating Ambient Temperature (T <sub>A</sub> )	μPD70732-16	μPD70732-20	μPD70732-25		
		120-pin Plastic QFP		120-pin Plastic TQFP	176-pin Ceramic PGA	
V <sub>DD</sub> = +5 V ± 10%	-10 to +70°C	○ (16 MHz)	○ (20 MHz)	○ (25 MHz)	○ (25 MHz)	○ (25 MHz)
	-40 to +85°C	—	—	○ (20 MHz)	○ (20 MHz)	—
V <sub>DD</sub> = 2.7 to 3.6 V	-40 to +85°C	—	—	○ (16 MHz)	○ (16 MHz)	—
V <sub>DD</sub> = 2.2 to 3.6 V	-40 to +85°C	—	—	○ (10 MHz)	○ (10 MHz)	—

★

- Remarks**
- : with electrical specifications  
 — : without electrical specifications
  - ( ) : maximum operating frequency

10.1 Specifications When  $V_{DD} = +5\text{ V} \pm 10\%$

(1)  $T_A = -10$  to  $+70^\circ\text{C}$

Absolute Maximum Ratings ( $T_A = 25^\circ\text{C}$ )

Parameter	Symbol	Test Conditions	Rating	Unit
Supply voltage	$V_{DD}$		-0.5 to +7.0	V
Input voltage	$V_I$	$V_{DD} = +5\text{ V} \pm 10\%$	-0.5 to $V_{DD} + 0.3$	V
Clock Input voltage	$V_K$	$V_{DD} = +5\text{ V} \pm 10\%$	-0.5 to $V_{DD} + 0.3$	V
Output voltage	$V_O$	$V_{DD} = +5\text{ V} \pm 10\%$	-0.5 to $V_{DD} + 0.3$	V
Operating ambient temperature	$T_A$		-10 to +70	$^\circ\text{C}$
Storage temperature	$T_{stg}$		-65 to +150	$^\circ\text{C}$

**Cautions** 1. Do not directly interconnect IC product output (or input/output) pins, or directly connect  $V_{DD}$  or  $V_{CC}$  to GND. However, open-drain pins and open-collector pins can be interconnected. Direct connection is also possible for an external circuit using timing design that avoids output collision with a pin that becomes high-impedance.

2. Product quality may suffer if the absolute maximum rating is exceeded for even a single parameter, or even momentarily.

In other words, the absolute maximum ratings are rated values at which the product is on the verge of suffering physical damage, and therefore, the product must be used under conditions which ensure that the absolute maximum ratings are not exceeded. As far as possible, the product should be used in a state in which the rated value is not approached. The ratings and test conditions shown in the DC characteristics and AC characteristics are the normal operation and quality assurance ranges of the product.

DC Characteristics ( $T_A = -10$  to  $+70^\circ\text{C}$ ,  $V_{DD} = +5\text{V} \pm 10\%$ )

Parameter	Symbol	Test Conditions	MIN.	TYP.	MAX.	Unit
Clock input voltage, high	$V_{KH}$		4.0		$V_{DD} + 0.3$	V
Clock input voltage, low	$V_{KL}$		-0.5		+0.6	V
Input voltage, high	$V_{IH}$		2.2		$V_{DD} + 0.3$	V
Input voltage, low	$V_{IL}$		-0.5		+0.8	V
Output voltage, high	$V_{OH}$	$I_{OH} = -400\ \mu\text{A}$	2.4			V
Output voltage, low	$V_{OL}$	$I_{OL} = 3.2\ \text{mA}$			0.45	V
Input leak current, high	$I_{LIH}$	$V_{IN} = V_{DD}$			10	$\mu\text{A}$
Input leak current, low	$I_{LIL}$	$V_{IN} = 0\ \text{V}$			-10	$\mu\text{A}$
Output leak current, high	$I_{LOH}$	$V_O = V_{DD}$			10	$\mu\text{A}$
Output leak current, low	$I_{LOL}$	$V_O = 0\ \text{V}$			-10	$\mu\text{A}$
Supply current	$I_{DD}$	f = 16 MHz		64 <sup>Note 2</sup>	160	mA
		f = 20 MHz		80 <sup>Note 2</sup>	200	
		f = 25 MHz		100 <sup>Note 2</sup>	240	
		Stopping clock <sup>Note 1</sup>		5		$\mu\text{A}$

**Notes** 1.  $V_{IL} = 0\ \text{V}$ ,  $V_{IH} = V_{DD}$  applied

2. In general benchmark test (Output pins are open.)

**Remark** Operating supply current is approximately proportional to operating clock frequency.

**Capacitance (T<sub>A</sub> = 25°C, V<sub>DD</sub> = +5 V ± 10%)**

Parameter	Symbol	Test Conditions	MIN.	MAX.	Unit
Input capacitance	C <sub>I</sub>	f <sub>c</sub> = 1 MHz		15	pF
I/O capacitance	C <sub>IO</sub>			15	pF

**AC Characteristics (T<sub>A</sub> = -10 to +70°C, V<sub>DD</sub> = +5V ± 10%)**

**Clock Input**

Parameter	Symbol	Test Conditions	μPD70732-16		μPD70732-20		μPD70732-25		Unit
			MIN.	MAX.	MIN.	MAX.	MIN.	MAX.	
Clock cycle	t <sub>CYK</sub>		62.5		50		40		ns
Clock pulse high-level width	t <sub>KKH</sub>		26		21		17		ns
Clock pulse low-level width	t <sub>KKL</sub>		26		21		17		ns
Clock rise time	t <sub>KR</sub>			5		4		3	ns
Clock fall time	t <sub>KF</sub>			5		4		3	ns

**Reset**

Parameter	Symbol	Test Conditions	μPD70732-16		μPD70732-20		μPD70732-25		Unit
			MIN.	MAX.	MIN.	MAX.	MIN.	MAX.	
$\overline{\text{RESET}}$ hold time (from V <sub>DD</sub> VALID)	t <sub>HVR</sub>		1000 + 20 t <sub>CYKR</sub>		1000 + 20 t <sub>CYKR</sub>		1000 + 20 t <sub>CYKR</sub>		ns
Clock cycle (at reset)	t <sub>CYKR</sub>		62.5	1000	50	1000	40	1000	ns
Clock high-level time (at reset)	t <sub>KKHR</sub>		26		21		17		ns
Clock low-level time (at reset)	t <sub>KKLR</sub>		26		21		17		ns
$\overline{\text{RESET}}$ setup time (to CLK↓, active)	t <sub>SRKF</sub>		10		10		10		ns
$\overline{\text{RESET}}$ setup time (to CLK↓, inactive)	t <sub>SRKR</sub>		10		10		10		ns
$\overline{\text{RESET}}$ hold time (from CLK↓)	t <sub>HKR</sub>		10		10		10		ns
$\overline{\text{RESET}}$ pulse low-level width (to CLK↓)	t <sub>WRL</sub>		20 t <sub>CYKR</sub>		20 t <sub>CYKR</sub>		20 t <sub>CYKR</sub>		ns

**Memory, I/O Access**

Parameter	Symbol	Test Conditions	μPD70732-16		μPD70732-20		μPD70732-25		Unit
			MIN.	MAX.	MIN.	MAX.	MIN.	MAX.	
Address, etc. output delay time (from CLK↑)	t <sub>DKA</sub>		2	20	2	15	2	15	ns
Address, etc. output hold time (from CLK↑)	t <sub>HKA</sub>		2	20	2	15	2	15	ns
$\overline{\text{BCYST}}$ output delay time (from CLK↑)	t <sub>DKBC</sub>		2	20	2	15	2	15	ns
$\overline{\text{BCYST}}$ output hold time (from CLK↑)	t <sub>HKBC</sub>		2	20	2	15	2	15	ns
$\overline{\text{DA}}$ output delay time (from CLK↑)	t <sub>DKDA</sub>		2	20	2	15	2	15	ns
$\overline{\text{DA}}$ output hold time (from CLK↑)	t <sub>HKDA</sub>		2	20	2	15	2	15	ns
$\overline{\text{READY}}$ setup time (to CLK↓)	t <sub>SRYK</sub>		6		5		4		ns
$\overline{\text{READY}}$ hold time (from CLK↓)	t <sub>HKRY</sub>		5		5		4		ns
Data setup time (to CLK↑)	t <sub>SDK</sub>		6		5		4		ns
Data hold time (from CLK↑)	t <sub>HKD</sub>		5		5		4		ns
Data output delay time (from active, from CLK↓)	t <sub>DKDT</sub>		2	20	2	15	2	15	ns
Data output hold time (to active, from CLK↓)	t <sub>HKDT</sub>		2	20	2	15	2	15	ns
Data output delay time (from float, from CLK↓)	t <sub>LZKDT</sub>		5	25	5	20	5	20	ns
Data output hold time (to float, from CLK↓)	t <sub>HZKDT</sub>		5	25	5	20	5	20	ns

**Dynamic Bus Sizing**

Parameter	Symbol	Test Conditions	μPD70732-16		μPD70732-20		μPD70732-25		Unit
			MIN.	MAX.	MIN.	MAX.	MIN.	MAX.	
$\overline{\text{SZRQ}}$ setup time (to CLK↓)	t <sub>SSZK</sub>		6		5		4		ns
$\overline{\text{SZRQ}}$ hold time (from CLK↓)	t <sub>HKSZ</sub>		5		5		4		ns

**Interrupt**

Parameter	Symbol	Test Conditions	μPD70732-16		μPD70732-20		μPD70732-25		Unit
			MIN.	MAX.	MIN.	MAX.	MIN.	MAX.	
$\overline{\text{NMI}}$ setup time (to CLK↓)	t <sub>SNK</sub>		6		5		4		ns
$\overline{\text{NMI}}$ hold time (from CLK↓)	t <sub>HKN</sub>		5		5		4		ns
INT, etc. setup time (to CLK↑)	t <sub>SIK</sub>		6		5		4		ns
INT, etc. hold time (from CLK↑)	t <sub>HKI</sub>		5		5		4		ns



**Bus Hold**

Parameter	Symbol	Test Conditions	μPD70732-16		μPD70732-20		μPD70732-25		Unit
			MIN.	MAX.	MIN.	MAX.	MIN.	MAX.	
$\overline{\text{HLDRQ}}$ setup time (to CLK↓)	t <sub>SHQK</sub>		6		5		4		ns
$\overline{\text{HLDRQ}}$ hold time (from CLK↓)	t <sub>HKHQ</sub>		5		5		4		ns
$\overline{\text{HLDAK}}$ output delay time (from CLK↑)	t <sub>DKHA</sub>		2	20	2	15	2	15	ns
$\overline{\text{HLDAK}}$ output hold time (from CLK↑)	t <sub>HKHA</sub>		2	20	2	15	2	15	ns
Address, etc. delay time (from active, from CLK↑)	t <sub>HZKA</sub>		2	25	2	20	2	20	ns
Address, etc. delay time (from float, from CLK↑)	t <sub>LZKA</sub>		2	25	2	20	2	20	ns
Data delay time (from active, from CLK↓)	t <sub>HZKD</sub>		5	25	5	20	5	20	ns
Data delay time (from float, from CLK↓)	t <sub>LZKD</sub>		5	25	5	20	5	20	ns
$\overline{\text{BCYST}}$ delay time (from active, from CLK↑)	t <sub>HZKBC</sub>		2	25	2	20	2	20	ns
$\overline{\text{BCYST}}$ delay time (from float, from CLK↑)	t <sub>LZKBC</sub>		2	25	2	20	2	20	ns
$\overline{\text{DA}}$ delay time (from active, from CLK↑)	t <sub>HZKDA</sub>		2	25	2	20	2	20	ns
$\overline{\text{DA}}$ delay time (from float, from CLK↑)	t <sub>LZKDA</sub>		2	25	2	20	2	20	ns

**AC Test Input Waveform (Except CLK)**

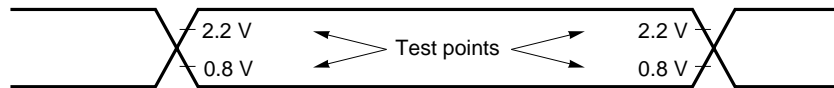

**AC Test Input Waveform (CLK)**

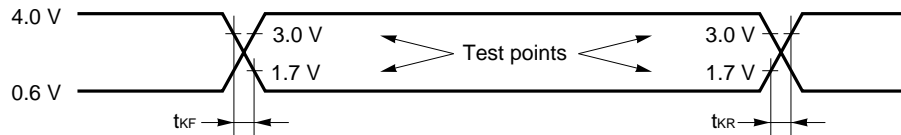

**AC Test Output Test Points**

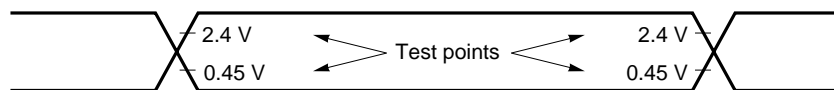

Load Conditions

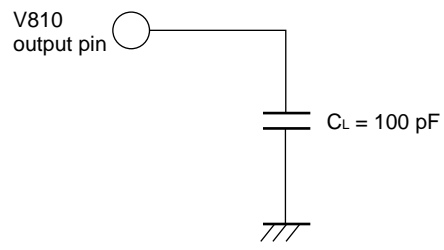

(2)  $T_A = -40$  to  $+85^\circ\text{C}$

**Absolute Maximum Ratings ( $T_A = 25^\circ\text{C}$ )**

Parameter	Symbol	Test Conditions	Rating	Unit
Supply voltage	$V_{DD}$		-0.5 to +7.0	V
Input voltage	$V_I$	$V_{DD} = +5\text{ V} \pm 10\%$	-0.5 to $V_{DD} + 0.3$	V
Clock Input voltage	$V_K$	$V_{DD} = +5\text{ V} \pm 10\%$	-0.5 to $V_{DD} + 0.3$	V
Output voltage	$V_O$	$V_{DD} = +5\text{ V} \pm 10\%$	-0.5 to $V_{DD} + 0.3$	V
Operating ambient temperature	$T_A$		-40 to +85	$^\circ\text{C}$
Storage temperature	$T_{stg}$		-65 to +150	$^\circ\text{C}$

- Cautions**
1. Do not directly interconnect IC product output (or input/output) pins, or directly connect  $V_{DD}$  or  $V_{CC}$  to GND. However, open-drain pins and open-collector pins can be interconnected. Direct connection is also possible for an external circuit using timing design that avoids output collision with a pin that becomes high-impedance.
  2. Product quality may suffer if the absolute maximum rating is exceeded for even a single parameter, or even momentarily.  
In other words, the absolute maximum ratings are rated values at which the product is on the verge of suffering physical damage, and therefore, the product must be used under conditions which ensure that the absolute maximum ratings are not exceeded. As far as possible, the product should be used in a state in which the rated value is not approached. The ratings and test conditions shown in the DC characteristics and AC characteristics are the normal operation and quality assurance ranges of the product.

**DC Characteristics ( $T_A = -40$  to  $+85^\circ\text{C}$ ,  $V_{DD} = +5\text{V} \pm 10\%$ )**

Parameter	Symbol	Test Conditions	MIN.	TYP.	MAX.	Unit
Clock input voltage, high	$V_{KH}$		4.0		$V_{DD} + 0.3$	V
Clock input voltage, low	$V_{KL}$		-0.5		+0.6	V
Input voltage, high	$V_{IH}$		2.2		$V_{DD} + 0.3$	V
Input voltage, low	$V_{IL}$		-0.5		+0.8	V
Output voltage, high	$V_{OH}$	$I_{OH} = -400\ \mu\text{A}$	2.4			V
Output voltage, low	$V_{OL}$	$I_{OL} = 3.2\ \text{mA}$			0.45	V
Input leak current, high	$I_{LIH}$	$V_{IN} = V_{DD}$			10	$\mu\text{A}$
Input leak current, low	$I_{LIL}$	$V_{IN} = 0\ \text{V}$			-10	$\mu\text{A}$
Output leak current, high	$I_{LOH}$	$V_O = V_{DD}$			10	$\mu\text{A}$
Output leak current, low	$I_{LOL}$	$V_O = 0\ \text{V}$			-10	$\mu\text{A}$
Supply current	$I_{DD}$	$f = 20\ \text{MHz}$		80 <sup>Note 2</sup>	200	mA
		Stopping clock <sup>Note 1</sup>		5		$\mu\text{A}$

- Notes**
1.  $V_{IL} = 0\ \text{V}$ ,  $V_{IH} = V_{DD}$  applied
  2. In general benchmark test (Output pins are open.)

**Remark** Operating supply current is approximately proportional to operating clock frequency.

**Capacitance (T<sub>A</sub> = 25°C, V<sub>DD</sub> = +5 V ± 10%)**

Parameter	Symbol	Test Conditions	MIN.	MAX.	Unit
Input capacitance	C <sub>i</sub>	f <sub>c</sub> = 1 MHz		15	pF
I/O capacitance	C <sub>io</sub>			15	pF

**AC Characteristics (T<sub>A</sub> = -40 to +85°C, V<sub>DD</sub> = +5V ± 10%)**

**Clock Input**

Parameter	Symbol	Test Conditions	μPD70732-25		Unit
			MIN.	MAX.	
Clock cycle	t <sub>CYK</sub>		50		ns
Clock pulse high-level width	t <sub>KKH</sub>		21		ns
Clock pulse low-level width	t <sub>KKL</sub>		21		ns
Clock rise time	t <sub>KR</sub>			4	ns
Clock fall time	t <sub>KF</sub>			4	ns

**Reset**

Parameter	Symbol	Test Conditions	μPD70732-25		Unit
			MIN.	MAX.	
$\overline{\text{RESET}}$ hold time (from V <sub>DD</sub> VALID)	t <sub>HVR</sub>		1000 + 20 t <sub>CYKR</sub>		ns
Clock cycle (at reset)	t <sub>CYKR</sub>		50	1000	ns
Clock high-level time (at reset)	t <sub>KKHR</sub>		21		ns
Clock low-level time (at reset)	t <sub>KKLR</sub>		21		ns
$\overline{\text{RESET}}$ setup time (to CLK↓, active)	t <sub>SRKF</sub>		10		ns
$\overline{\text{RESET}}$ setup time (to CLK↓, inactive)	t <sub>SRKR</sub>		10		ns
$\overline{\text{RESET}}$ hold time (from CLK↓)	t <sub>HKR</sub>		10		ns
$\overline{\text{RESET}}$ pulse low-level width (to CLK↓)	t <sub>WRL</sub>		20 t <sub>CYKR</sub>		ns

**Memory, I/O Access**

Parameter	Symbol	Test Conditions	μPD70732-25		Unit
			MIN.	MAX.	
Address, etc. output delay time (from CLK↑)	t <sub>DKA</sub>		1	15	ns
Address, etc. output hold time (from CLK↑)	t <sub>HKA</sub>		1	15	ns
$\overline{\text{BCYST}}$ output delay time (from CLK↑)	t <sub>DKBC</sub>		1	15	ns
$\overline{\text{BCYST}}$ output hold time (from CLK↑)	t <sub>HKBC</sub>		1	15	ns
$\overline{\text{DA}}$ output delay time (from CLK↑)	t <sub>DKDA</sub>		1	15	ns
$\overline{\text{DA}}$ output hold time (from CLK↑)	t <sub>HKDA</sub>		1	15	ns
$\overline{\text{READY}}$ setup time (to CLK↓)	t <sub>SRYK</sub>		5		ns
$\overline{\text{READY}}$ hold time (from CLK↓)	t <sub>HKRY</sub>		5		ns
Data setup time (to CLK↑)	t <sub>SDK</sub>		5		ns
Data hold time (from CLK↑)	t <sub>HKD</sub>		5		ns
Data output delay time (from active, from CLK↓)	t <sub>DKDT</sub>		1	15	ns
Data output hold time (to active, from CLK↓)	t <sub>HKDT</sub>		1	15	ns
Data output delay time (from float, from CLK↓)	t <sub>LZKDT</sub>		5	20	ns
Data output hold time (to float, from CLK↓)	t <sub>HZKDT</sub>		5	20	ns

**Dynamic Bus Sizing**

Parameter	Symbol	Test Conditions	μPD70732-25		Unit
			MIN.	MAX.	
$\overline{\text{SZRQ}}$ setup time (to CLK↓)	t <sub>SSZK</sub>		5		ns
$\overline{\text{SZRQ}}$ hold time (from CLK↓)	t <sub>HSZK</sub>		5		ns

**Interrupt**

Parameter	Symbol	Test Conditions	μPD70732-25		Unit
			MIN.	MAX.	
$\overline{\text{NMI}}$ setup time (to CLK↓)	t <sub>SNK</sub>		5		ns
$\overline{\text{NMI}}$ hold time (from CLK↓)	t <sub>HKN</sub>		5		ns
INT, etc. setup time (to CLK↑)	t <sub>SIK</sub>		5		ns
INT, etc. hold time (from CLK↑)	t <sub>HKI</sub>		5		ns

**Bus Hold**

Parameter	Symbol	Test Conditions	μPD70732-25		Unit
			MIN.	MAX.	
HLD $\overline{\text{RQ}}$ setup time (to CLK $\downarrow$ )	t <sub>SHQK</sub>		5		ns
HLD $\overline{\text{RQ}}$ hold time (from CLK $\downarrow$ )	t <sub>HKHQ</sub>		5		ns
HLD $\overline{\text{AK}}$ output delay time (from CLK $\uparrow$ )	t <sub>DKHA</sub>		1	15	ns
HLD $\overline{\text{AK}}$ output hold time (from CLK $\uparrow$ )	t <sub>HKHA</sub>		1	15	ns
Address, etc. delay time (from active, from CLK $\uparrow$ )	t <sub>HZKA</sub>		2	20	ns
Address, etc. delay time (from float, from CLK $\uparrow$ )	t <sub>LZKA</sub>		2	20	ns
Data delay time (from active, from CLK $\downarrow$ )	t <sub>HZKD</sub>		5	20	ns
Data delay time (from float, from CLK $\downarrow$ )	t <sub>LZKD</sub>		5	20	ns
$\overline{\text{BCYST}}$ delay time (from active, from CLK $\uparrow$ )	t <sub>HZKBC</sub>		2	20	ns
$\overline{\text{BCYST}}$ delay time (from float, from CLK $\uparrow$ )	t <sub>LZKBC</sub>		2	20	ns
$\overline{\text{DA}}$ delay time (from active, from CLK $\uparrow$ )	t <sub>HZKDA</sub>		2	20	ns
$\overline{\text{DA}}$ delay time (from float, from CLK $\uparrow$ )	t <sub>LZKDA</sub>		2	20	ns

**AC Test Input Waveform (Except CLK)**

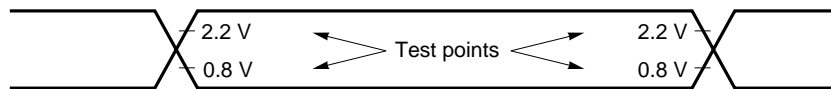

**AC Test Input Waveform (CLK)**

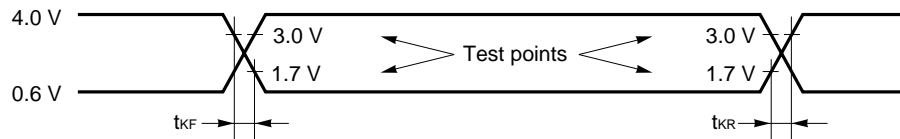

**AC Test Output Test Points**

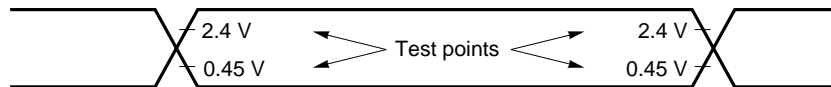

**Load Conditions**

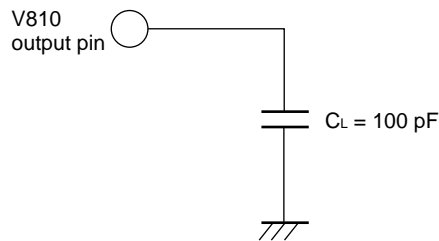

10.2 Specifications When  $V_{DD} = 2.7$  to  $3.6$  V

Absolute Maximum Ratings ( $T_A = 25^\circ\text{C}$ )

Parameter	Symbol	Test Conditions	Rating	Unit
Supply voltage	$V_{DD}$		-0.5 to +7.0	V
Input voltage	$V_I$	$V_{DD} = 2.7$ to $3.6$ V	-0.5 to $V_{DD} + 0.3$	V
Clock Input voltage	$V_K$	$V_{DD} = 2.7$ to $3.6$ V	-0.5 to $V_{DD} + 0.3$	V
Output voltage	$V_O$	$V_{DD} = 2.7$ to $3.6$ V	-0.5 to $V_{DD} + 0.3$	V
Operating ambient temperature	$T_A$		-40 to +85	$^\circ\text{C}$
Storage temperature	$T_{stg}$		-65 to +150	$^\circ\text{C}$

- Cautions**
1. Do not directly interconnect IC product output (or input/output) pins, or directly connect  $V_{DD}$  or  $V_{CC}$  to GND. However, open-drain pins and open-collector pins can be interconnected. Direct connection is also possible for an external circuit using timing design that avoids output collision with a pin that becomes high-impedance.
  2. Product quality may suffer if the absolute maximum rating is exceeded for even a single parameter, or even momentarily.  
In other words, the absolute maximum ratings are rated values at which the product is on the verge of suffering physical damage, and therefore, the product must be used under conditions which ensure that the absolute maximum ratings are not exceeded. As far as possible, the product should be used in a state in which the rated value is not approached. The ratings and test conditions shown in the DC characteristics and AC characteristics are the normal operation and quality assurance ranges of the product.

DC Characteristics ( $T_A = -40$  to  $+85^\circ\text{C}$ ,  $V_{DD} = 2.7$  to  $3.6$  V)

Parameter	Symbol	Test Conditions	MIN.	TYP.	MAX.	Unit
Clock input voltage, high	$V_{KH}$		$0.8 V_{DD}$		$V_{DD} + 0.3$	V
Clock input voltage, low	$V_{KL}$		-0.5		$+0.2 V_{DD}$	V
Input voltage, high	$V_{IH}$		2.0		$V_{DD} + 0.3$	V
Input voltage, low	$V_{IL}$		-0.5		+0.6	V
Output voltage, high	$V_{OH}$	$I_{OH} = -2.0$ mA	$0.85 V_{DD}$			V
		$I_{OH} = -100$ μA	$V_{DD} - 0.2$			V
Output voltage, low	$V_{OL}$	$I_{OL} = 3.2$ mA			0.4	V
Input leak current, high	$I_{LIH}$	$V_{IN} = V_{DD}$			5	μA
Input leak current, low	$I_{LIL}$	$V_{IN} = 0$ V			-5	μA
Output leak current, high	$I_{LOH}$	$V_O = V_{DD}$			5	μA
Output leak current, low	$I_{LOL}$	$V_O = 0$ V			-5	μA
Supply current	$I_{DD}$	$f = 16$ MHz		38 <sup>Note 2</sup>	100	mA
		Stopping clock <sup>Note 1</sup>		3	30	μA

- Notes**
1.  $V_{IL} = 0$  V,  $V_{IH} = V_{DD}$  applied
  2. In general benchmark test (Output pins are open.)

**Remark** Operating supply current is approximately proportional to operating clock frequency.

**Capacitance (T<sub>A</sub> = 25°C, V<sub>DD</sub> = 2.7 to 3.6 V)**

Parameter	Symbol	Test Conditions	MIN.	MAX.	Unit
Input capacitance	C <sub>i</sub>	f <sub>c</sub> = 1 MHz		15	pF
I/O capacitance	C <sub>io</sub>			15	pF

**AC Characteristics (T<sub>A</sub> = -40 to +85°C, V<sub>DD</sub> = 2.7 to 3.6 V)**

**Clock Input**

Parameter	Symbol	Test Conditions	μPD70732-25		Unit
			MIN.	MAX.	
Clock cycle	t <sub>cyk</sub>		62.5		ns
Clock pulse high-level width	t <sub>kKH</sub>		26		ns
Clock pulse low-level width	t <sub>kKL</sub>		26		ns
Clock rise time	t <sub>kR</sub>			5	ns
Clock fall time	t <sub>kF</sub>			5	ns

**Reset**

Parameter	Symbol	Test Conditions	μPD70732-25		Unit
			MIN.	MAX.	
RESET hold time (from V <sub>DD</sub> VALID)	t <sub>HVR</sub>		1000 + 20t <sub>cyKR</sub>		ns
Clock cycle (at reset)	t <sub>cyKR</sub>		62.5	1000	ns
Clock high-level time (at reset)	t <sub>kKHR</sub>		26		ns
Clock low-level time (at reset)	t <sub>kKLR</sub>		26		ns
RESET setup time (to CLK↓, active)	t <sub>SRKF</sub>		10		ns
RESET setup time (to CLK↓, inactive)	t <sub>SRKR</sub>		10		ns
RESET hold time (from CLK↓)	t <sub>HKR</sub>		10		ns
RESET pulse low-level width (to CLK↓)	t <sub>WRL</sub>		20t <sub>cyKR</sub>		ns



**Memory, I/O Access**

Parameter	Symbol	Test Conditions	μPD70732-25		Unit
			MIN.	MAX.	
Address etc. output delay time (from CLK↑)	t <sub>DKA</sub>		1	25	ns
Address etc. output hold time (from CLK↑)	t <sub>HKA</sub>		1	25	ns
$\overline{\text{BCYST}}$ output delay time (from CLK↑)	t <sub>DKBC</sub>		1	25	ns
$\overline{\text{BCYST}}$ output hold time (from CLK↑)	t <sub>HKBC</sub>		1	25	ns
$\overline{\text{DA}}$ output delay time (from CLK↑)	t <sub>DKDA</sub>		1	25	ns
$\overline{\text{DA}}$ output hold time (from CLK↑)	t <sub>HKDA</sub>		1	25	ns
$\overline{\text{READY}}$ setup time (to CLK↓)	t <sub>SRYK</sub>		8		ns
$\overline{\text{READY}}$ hold time (from CLK↓)	t <sub>HKRY</sub>		5		ns
Data setup time (to CLK↑)	t <sub>SDK</sub>		8		ns
Data hold time (from CLK↑)	t <sub>HKD</sub>		5		ns
Data output delay time (from active, from CLK↓)	t <sub>DKDT</sub>		1	35	ns
Data output hold time (to active, from CLK↓)	t <sub>HKDT</sub>		1	35	ns
Data output delay time (from float, from CLK↓)	t <sub>LZKDT</sub>		3	40	ns
Data output hold time (to float, from CLK↓)	t <sub>HZKDT</sub>		3	40	ns

**Dynamic Bus Sizing**

Parameter	Symbol	Test Conditions	μPD70732-25		Unit
			MIN.	MAX.	
$\overline{\text{SZRQ}}$ setup time (to CLK↓)	t <sub>SSZK</sub>		8		ns
$\overline{\text{SZRQ}}$ hold time (from CLK↓)	t <sub>HKSZ</sub>		5		ns

**Interrupt**

Parameter	Symbol	Test Conditions	μPD70732-25		Unit
			MIN.	MAX.	
$\overline{\text{NMI}}$ setup time (to CLK↓)	t <sub>SNK</sub>		8		ns
$\overline{\text{NMI}}$ hold time (from CLK↓)	t <sub>HKN</sub>		5		ns
INT etc. setup time (to CLK↑)	t <sub>SIK</sub>		8		ns
INT etc. hold time (from CLK↑)	t <sub>HKI</sub>		5		ns

**Bus Hold**

Parameter	Symbol	Test Conditions	μPD70732-25		Unit
			MIN.	MAX.	
$\overline{\text{HLDRQ}}$ setup time (to CLK↓)	t <sub>SHQK</sub>		8		ns
$\overline{\text{HLDRQ}}$ hold time (from CLK↓)	t <sub>HKHQ</sub>		5		ns
$\overline{\text{HLDAK}}$ output delay time (from CLK↑)	t <sub>DKHA</sub>		1	25	ns
$\overline{\text{HLDAK}}$ output hold time (from CLK↑)	t <sub>HKHA</sub>		1	25	ns
Address, etc. delay time (from active, from CLK↑)	t <sub>HZKA</sub>		3	30	ns
Address, etc. delay time (from float, from CLK↑)	t <sub>LZKA</sub>		3	30	ns
Data delay time (from active, from CLK↓)	t <sub>HZKD</sub>		3	40	ns
Data delay time (from float, from CLK↓)	t <sub>LZKD</sub>		3	40	ns
$\overline{\text{BCYST}}$ delay time (from active, from CLK↑)	t <sub>HZKBC</sub>		3	30	ns
$\overline{\text{BCYST}}$ delay time (from float, from CLK↑)	t <sub>LZKBC</sub>		3	30	ns
$\overline{\text{DA}}$ delay time (from active, from CLK↑)	t <sub>HZKDA</sub>		3	30	ns
$\overline{\text{DA}}$ delay time (from float, from CLK↑)	t <sub>LZKDA</sub>		3	30	ns

**AC Test Input Waveform (Except CLK)**

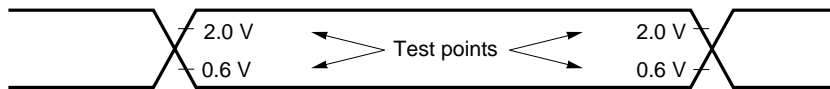

**AC Test Input Waveform (CLK)**

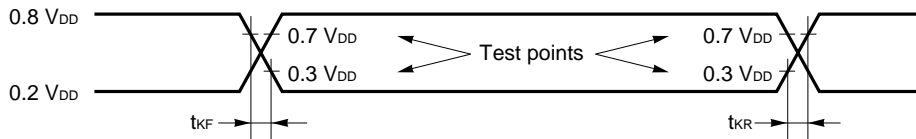

**AC Test Output Test Points**

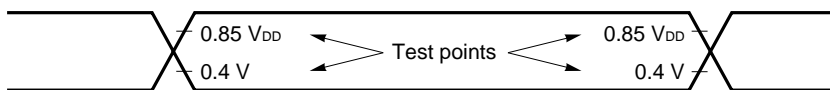

**Load Conditions**

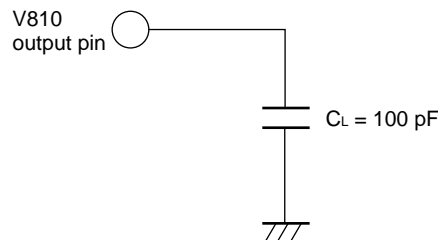

10.3 Specifications When  $V_{DD} = 2.2$  to  $3.6$  V

Absolute Maximum Ratings ( $T_A = 25^\circ\text{C}$ )

Parameter	Symbol	Test Conditions	Rating	Unit
Supply voltage	$V_{DD}$		-0.5 to +7.0	V
Input voltage	$V_I$	$V_{DD} = 2.2$ to $3.6$ V	-0.5 to $V_{DD} + 0.3$	V
Clock Input voltage	$V_K$	$V_{DD} = 2.2$ to $3.6$ V	-0.5 to $V_{DD} + 0.3$	V
Output voltage	$V_O$	$V_{DD} = 2.2$ to $3.6$ V	-0.5 to $V_{DD} + 0.3$	V
Operating ambient temperature	$T_A$		-40 to +85	$^\circ\text{C}$
Storage temperature	$T_{stg}$		-65 to +150	$^\circ\text{C}$

- Cautions**
1. Do not directly interconnect IC product output (or input/output) pins, or directly connect  $V_{DD}$  or  $V_{CC}$  to GND. However, open-drain pins and open-collector pins can be interconnected. Direct connection is also possible for an external circuit using timing design that avoids output collision with a pin that becomes high-impedance.
  2. Product quality may suffer if the absolute maximum rating is exceeded for even a single parameter, or even momentarily.  
In other words, the absolute maximum ratings are rated values at which the product is on the verge of suffering physical damage, and therefore, the product must be used under conditions which ensure that the absolute maximum ratings are not exceeded. As far as possible, the product should be used in a state in which the rated value is not approached. The ratings and test conditions shown in the DC characteristics and AC characteristics are the normal operation and quality assurance ranges of the product.

DC Characteristics ( $T_A = -40$  to  $+85^\circ\text{C}$ ,  $V_{DD} = 2.2$  to  $3.6$  V)

Parameter	Symbol	Test Conditions	MIN.	TYP.	MAX.	Unit
Clock input voltage, high	$V_{KH}$		$0.8 V_{DD}$		$V_{DD} + 0.3$	V
Clock input voltage, low	$V_{KL}$		-0.5		$+0.2 V_{DD}$	V
Input voltage, high	$V_{IH}$	$V_{DD} \cdot 2.5$ V	2.0		$V_{DD} + 0.3$	V
		$V_{DD} - 2.5$ V	$0.8 V_{DD}$		$V_{DD} + 0.3$	V
Input voltage, low	$V_{IL}$		-0.5		$+0.2 V_{DD}$	V
Output voltage, high	$V_{OH}$	$I_{OH} = -2.0$ mA	$0.85 V_{DD}$			V
		$I_{OH} = -100$ μA	$V_{DD} - 0.2$			V
Output voltage, low	$V_{OL}$	$I_{OL} = 3.2$ mA			0.4	V
Input leak current, high	$I_{LIH}$	$V_{IN} = V_{DD}$			5	μA
Input leak current, low	$I_{LIL}$	$V_{IN} = 0$ V			-5	μA
Output leak current, high	$I_{LOH}$	$V_O = V_{DD}$			5	μA
Output leak current, low	$I_{LOL}$	$V_O = 0$ V			-5	μA
Supply current	$I_{DD}$	$f = 10$ MHz		24 <sup>Note 2</sup>	70	mA
		Stopping clock <sup>Note 1</sup>		3	30	μA

- Notes**
1.  $V_{IL} = 0$  V,  $V_{IH} = V_{DD}$  applied
  2. In general benchmark test (Output pins are open.)

**Remark** Operating supply current is approximately proportional to operating clock frequency.

**Capacitance (T<sub>A</sub> = 25°C, V<sub>DD</sub> = 2.2 to 3.6 V)**

Parameter	Symbol	Test Conditions	MIN.	MAX.	Unit
Input capacitance	C <sub>i</sub>	f <sub>c</sub> = 1 MHz		15	pF
I/O capacitance	C <sub>io</sub>			15	pF

**AC Characteristics (T<sub>A</sub> = -40 to +85°C, V<sub>DD</sub> = 2.2 to 3.6 V)**

**Clock Input**

Parameter	Symbol	Test Conditions	μPD70732-25		Unit
			MIN.	MAX.	
Clock cycle	t <sub>CYK</sub>		100		ns
Clock pulse high-level width	t <sub>KKH</sub>		40		ns
Clock pulse low-level width	t <sub>KKL</sub>		40		ns
Clock rise time	t <sub>KR</sub>			10	ns
Clock fall time	t <sub>KF</sub>			10	ns

**Reset**

Parameter	Symbol	Test Conditions	μPD70732-25		Unit
			MIN.	MAX.	
RESET hold time (from V <sub>DD</sub> VALID)	t <sub>HVR</sub>		1000 + 20t <sub>CYKR</sub>		ns
Clock cycle (at reset)	t <sub>CYKR</sub>		100	1000	ns
Clock high-level time (at reset)	t <sub>KKHR</sub>		40		ns
Clock low-level time (at reset)	t <sub>KKLR</sub>		40		ns
RESET setup time (to CLK↓, active)	t <sub>SRKF</sub>		10		ns
RESET setup time (to CLK↓, inactive)	t <sub>SRKR</sub>		10		ns
RESET hold time (from CLK↓)	t <sub>HKR</sub>		15		ns
RESET pulse low-level width (to CLK↓)	t <sub>WRL</sub>		20t <sub>CYKR</sub>		ns

**Memory, I/O Access**

Parameter	Symbol	Test Conditions	μPD70732-25		Unit
			MIN.	MAX.	
Address, etc. output delay time (from CLK↑)	t <sub>DKA</sub>		1	35	ns
Address, etc. output hold time (from CLK↑)	t <sub>HKA</sub>		1	35	ns
$\overline{\text{BCYST}}$ output delay time (from CLK↑)	t <sub>DKBC</sub>		1	35	ns
$\overline{\text{BCYST}}$ output hold time (from CLK↑)	t <sub>HKBC</sub>		1	35	ns
$\overline{\text{DA}}$ output delay time (from CLK↑)	t <sub>DKDA</sub>		1	35	ns
$\overline{\text{DA}}$ output hold time (from CLK↑)	t <sub>HKDA</sub>		1	35	ns
$\overline{\text{READY}}$ setup time (to CLK↓)	t <sub>SRYK</sub>		15		ns
$\overline{\text{READY}}$ hold time (from CLK↓)	t <sub>HKRY</sub>		5		ns
Data setup time (to CLK↑)	t <sub>SDK</sub>		15		ns
Data hold time (from CLK↑)	t <sub>HKD</sub>		5		ns
Data output delay time (from active, from CLK↓)	t <sub>DKDT</sub>		1	50	ns
Data output hold time (to active, from CLK↓)	t <sub>HKDT</sub>		1	50	ns
Data output delay time (from float, from CLK↓)	t <sub>LZKDT</sub>		3	50	ns
Data output hold time (to float, from CLK↓)	t <sub>HZKDT</sub>		3	50	ns

**Dynamic Bus Sizing**

Parameter	Symbol	Test Conditions	μPD70732-25		Unit
			MIN.	MAX.	
$\overline{\text{SZRQ}}$ setup time (to CLK↓)	t <sub>SSZK</sub>		15		ns
$\overline{\text{SZRQ}}$ hold time (from CLK↓)	t <sub>HKSZ</sub>		5		ns

**Interrupt**

Parameter	Symbol	Test Conditions	μPD70732-25		Unit
			MIN.	MAX.	
$\overline{\text{NMI}}$ setup time (to CLK↓)	t <sub>SNK</sub>		15		ns
$\overline{\text{NMI}}$ hold time (from CLK↓)	t <sub>HKN</sub>		5		ns
INT, etc. setup time (to CLK↑)	t <sub>SIK</sub>		15		ns
INT, etc. hold time (from CLK↑)	t <sub>HKI</sub>		5		ns

**Bus Hold**

Parameter	Symbol	Test Conditions	μPD70732-25		Unit
			MIN.	MAX.	
$\overline{\text{HLDRQ}}$ setup time (to CLK↓)	t <sub>SHQK</sub>		15		ns
$\overline{\text{HLDRQ}}$ hold time (from CLK↓)	t <sub>HKHQ</sub>		5		ns
$\overline{\text{HLDAK}}$ output delay time (from CLK↑)	t <sub>DKHA</sub>		1	35	ns
$\overline{\text{HLDAK}}$ output hold time (from CLK↑)	t <sub>HKHA</sub>		1	35	ns
Address, etc. delay time (from active, from CLK↑)	t <sub>HZKA</sub>		3	35	ns
Address, etc. delay time (from float, from CLK↑)	t <sub>LZKA</sub>		3	35	ns
Data delay time (from active, from CLK↓)	t <sub>HZKD</sub>		3	50	ns
Data delay time (from float, from CLK↓)	t <sub>LZKD</sub>		3	50	ns
$\overline{\text{BCYST}}$ delay time (from active, from CLK↑)	t <sub>HZKBC</sub>		3	35	ns
$\overline{\text{BCYST}}$ delay time (from float, from CLK↑)	t <sub>LZKBC</sub>		3	35	ns
$\overline{\text{DA}}$ delay time (from active, from CLK↑)	t <sub>HZKDA</sub>		3	35	ns
$\overline{\text{DA}}$ delay time (from float, from CLK↑)	t <sub>LZKDA</sub>		3	35	ns

**AC Test Input Waveform (Except CLK)**

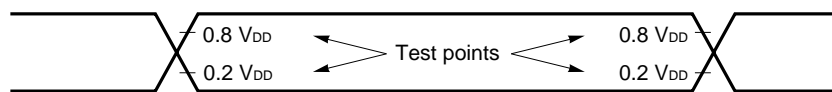

**AC Test Input Waveform (CLK)**

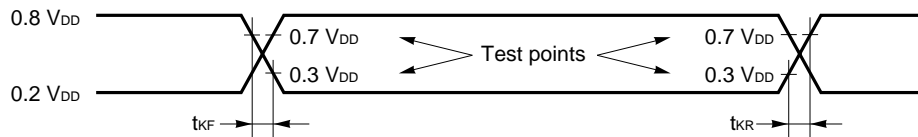

**AC Test Output Test Points**

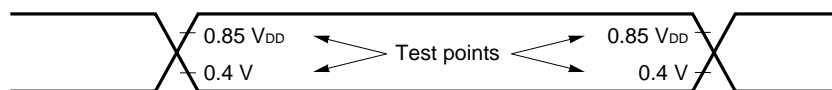

**Load Conditions**

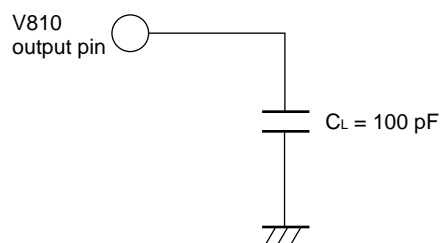

**Clock Timing**

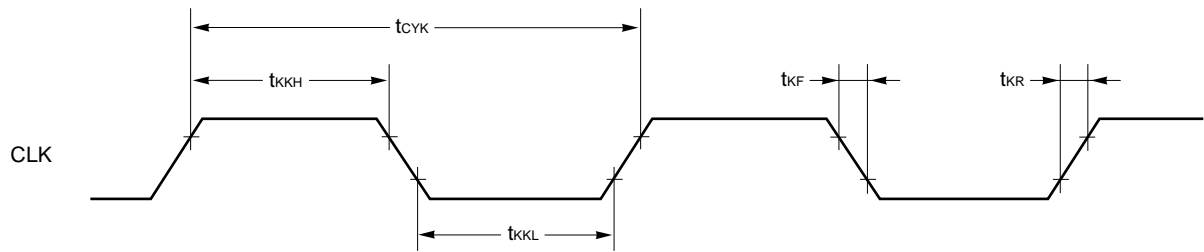

**Reset Timing**

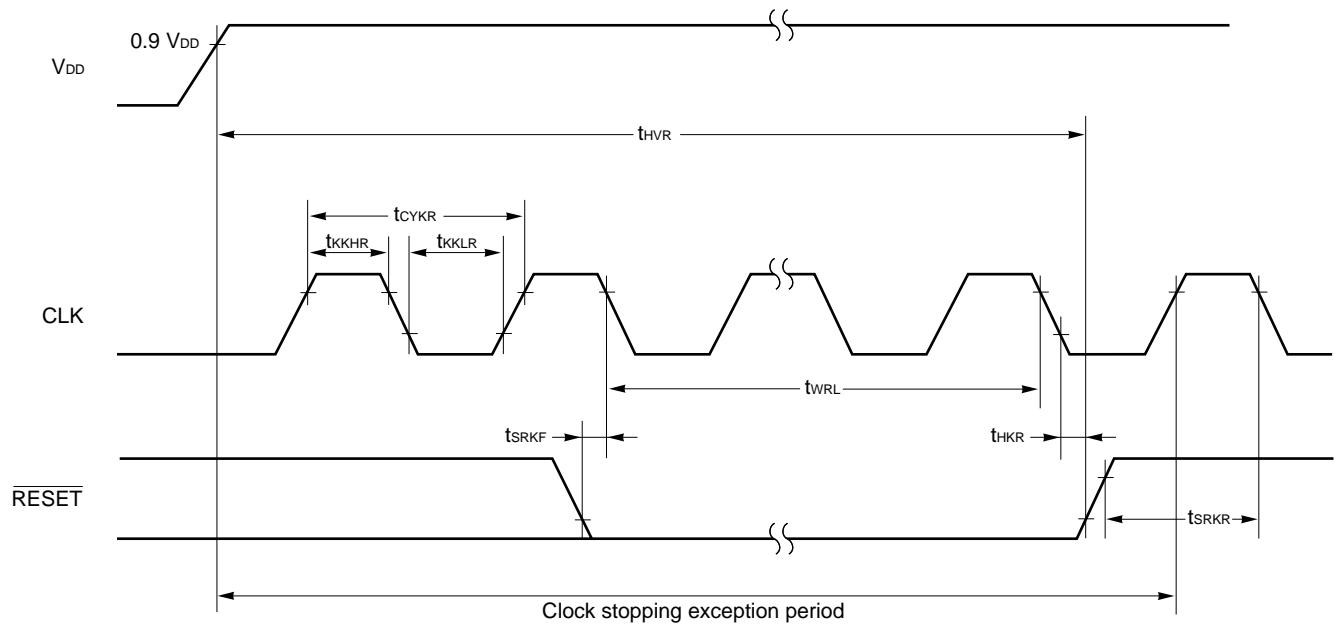

Memory, I/O Access Timing

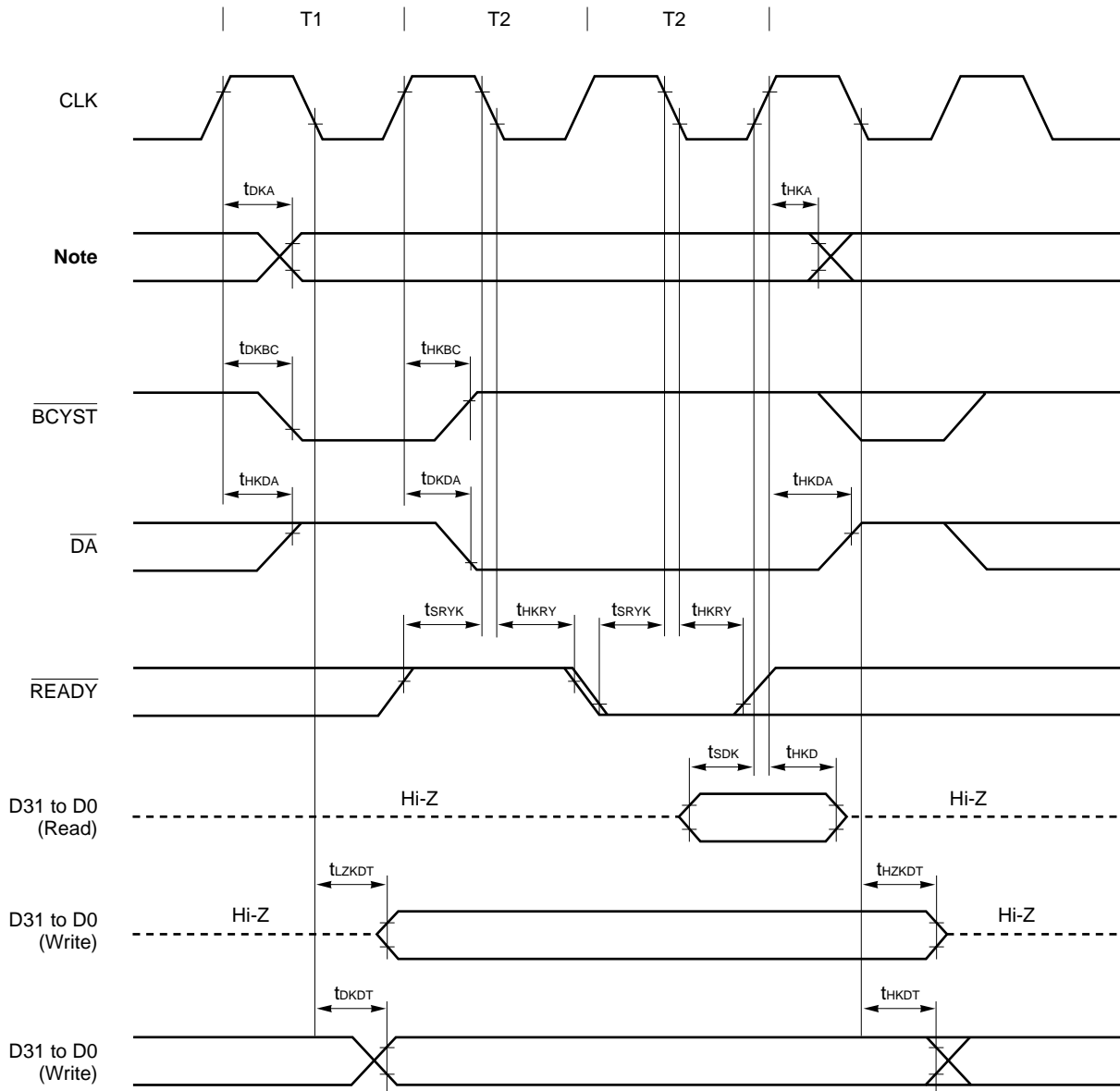

**Note** A31 to A1,  $\overline{BE3}$  to  $\overline{BE0}$ ,  $\overline{R/W}$ ,  $\overline{MRQ}$ , ST1, ST0, BLOCK,  $\overline{ADRSERR}$



Dynamic Bus Sizing Timing

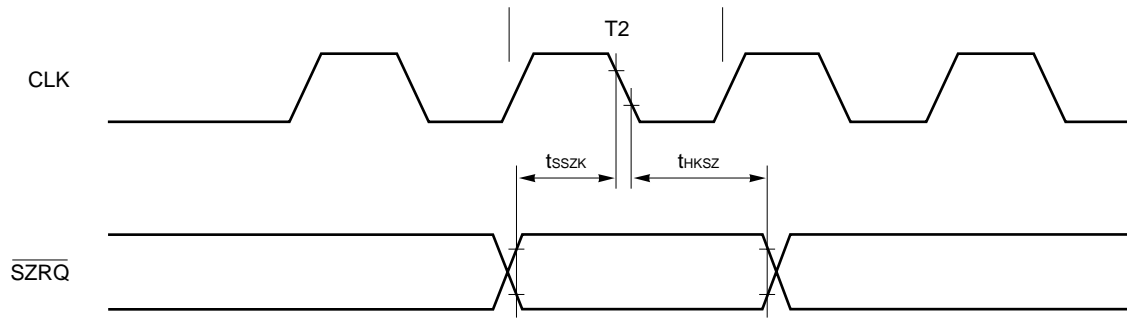

Interrupt Timing

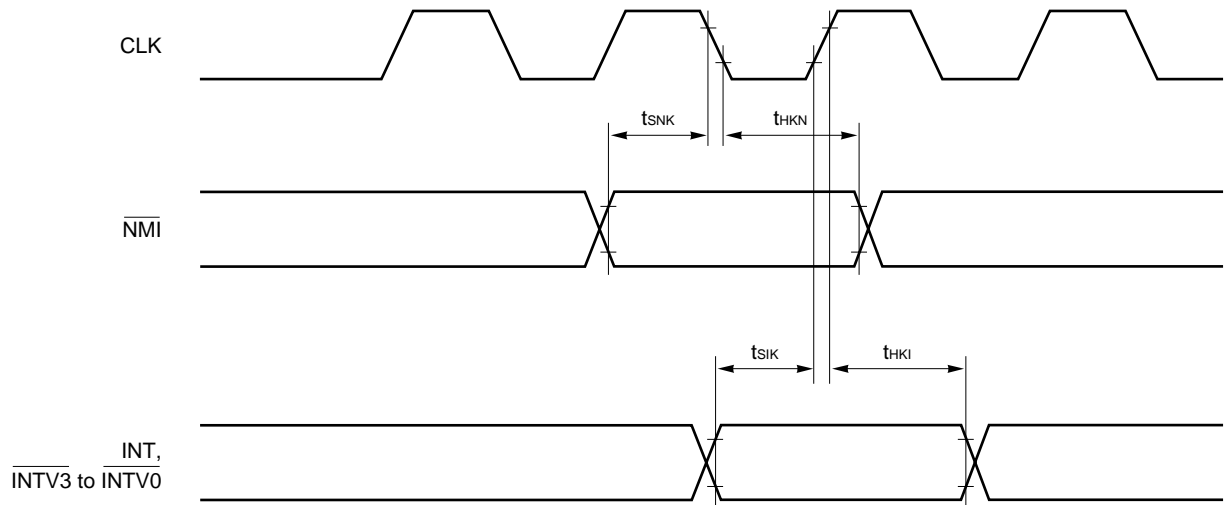

## Bus Hold Timing

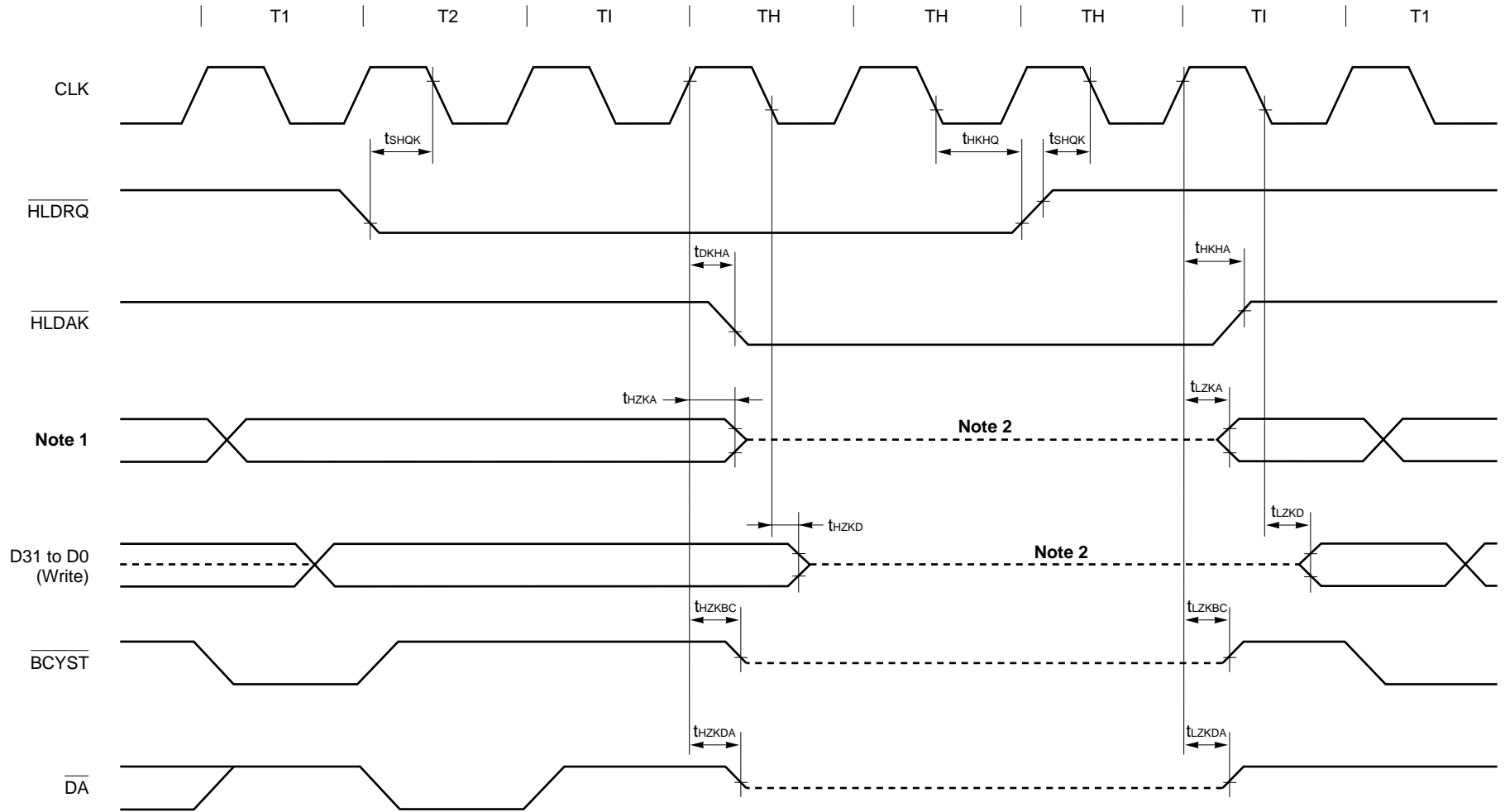

- Notes**
1. A31 to A1,  $\overline{BE3}$  to  $\overline{BE0}$ ,  $R/\overline{W}$ ,  $\overline{MRQ}$ ,  $ST1$ ,  $ST0$
  2. The level immediately before the high-impedance state has been stored internally.

**Remark** A dashed line indicates high impedance.

11. PACKAGE DRAWINGS

120-pin plastic QFP (28 x 28)

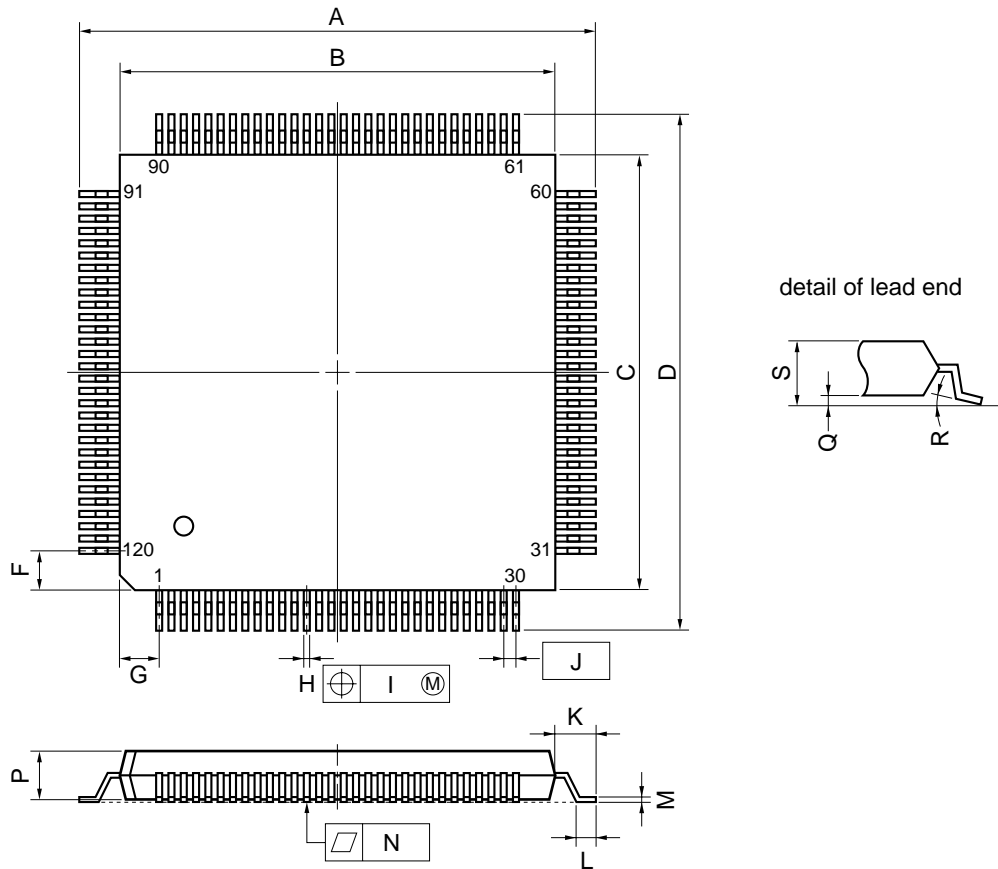

**NOTE**

Each lead centerline is located within 0.15 mm (0.006 inch) of its true position (T.P.) at maximum material condition.

ITEM	MILLIMETERS	INCHES
A	32.0±0.3	1.260±0.012
B	28.0±0.2	1.102 <sup>+0.009</sup> <sub>-0.008</sub>
C	28.0±0.2	1.102 <sup>+0.009</sup> <sub>-0.008</sub>
D	32.0±0.3	1.260±0.012
F	2.4	0.094
G	2.4	0.094
H	0.35±0.10	0.014 <sup>+0.004</sup> <sub>-0.005</sub>
I	0.15	0.006
J	0.8 (T.P.)	0.031 (T.P.)
K	2.0±0.2	0.079 <sup>+0.009</sup> <sub>-0.008</sub>
L	0.8±0.2	0.031 <sup>+0.009</sup> <sub>-0.008</sub>
M	0.15 <sup>+0.10</sup> <sub>-0.05</sub>	0.006 <sup>+0.004</sup> <sub>-0.003</sub>
N	0.1	0.004
P	3.2	0.126
Q	0.1±0.1	0.004±0.004
R	5°±5°	5°±5°
S	3.5 MAX.	0.138 MAX.

P120GD-80-LBB, MBB-1

★ 120-pin plastic TQFP (Fine pitch) (14 x 14)

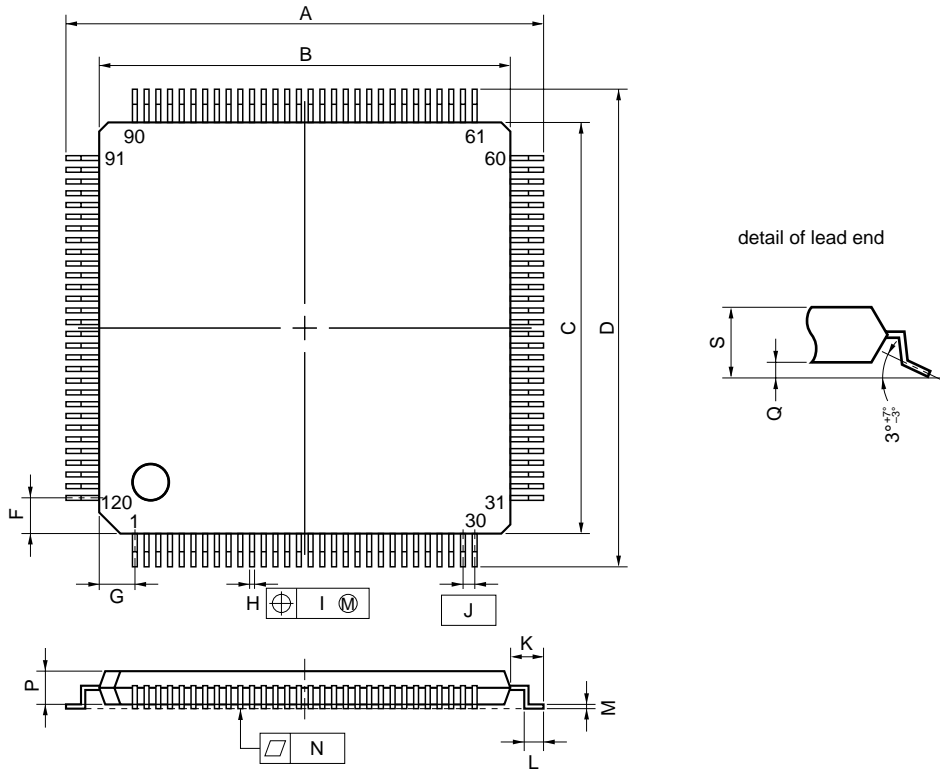

**NOTE**

Each lead centerline is located within 0.09 mm (0.004 inch) of its true position (T.P.) at maximum material condition.

**S120GC-40-9EV**

ITEM	MILLIMETERS	INCHES
A	16.0±0.2	0.630±0.008
B	14.0±0.2	0.551 <sup>+0.009</sup> <sub>-0.008</sub>
C	14.0±0.2	0.551 <sup>+0.009</sup> <sub>-0.008</sub>
D	16.0±0.2	0.630±0.008
F	1.2	0.047
G	1.2	0.047
H	0.18±0.05	0.007±0.002
I	0.09	0.004
J	0.4 (T.P.)	0.016 (T.P.)
K	1.0±0.2	0.039 <sup>+0.009</sup> <sub>-0.008</sub>
L	0.5±0.2	0.020 <sup>+0.008</sup> <sub>-0.009</sub>
M	0.145±0.05	0.006 <sup>+0.002</sup> <sub>-0.003</sub>
N	0.08	0.003
P	1.0±0.1	0.039 <sup>+0.005</sup> <sub>-0.004</sub>
Q	0.1±0.05	0.004±0.002
S	1.2 MAX.	0.048 MAX.

176-pin ceramic PGA (Seamweld)

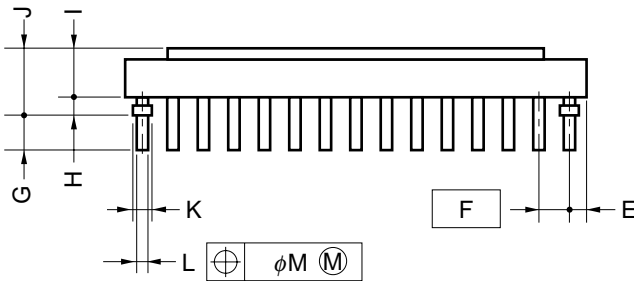
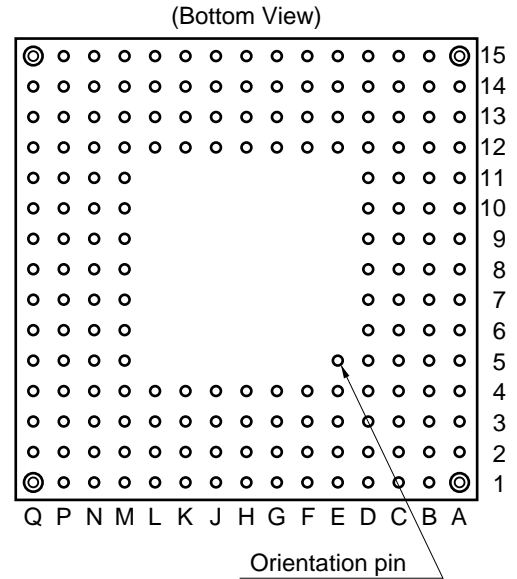
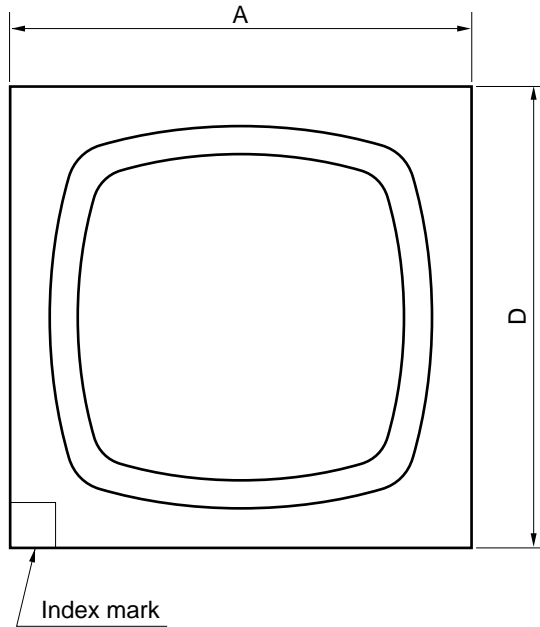

**NOTE**  
 Each lead centerline is located within  $\phi 0.5$  mm ( $\phi 0.020$  inch) of its true position (T.P.) at maximum material condition.

ITEM	MILLIMETERS	INCHES
A	38.1±0.4	1.500 <sup>+0.016</sup> <sub>-0.015</sub>
D	38.1±0.4	1.500 <sup>+0.016</sup> <sub>-0.015</sub>
E	1.27	0.050
F	2.54 (T.P.)	0.100 (T.P.)
G	2.8±0.3	0.110 <sup>+0.012</sup> <sub>-0.011</sub>
H	0.5 MIN.	0.019 MIN.
I	2.81	0.111
J	4.57 MAX.	0.180 MAX.
K	$\phi 1.2 \pm 0.2$	$\phi 0.047$ <sup>+0.008</sup> <sub>-0.007</sub>
L	$\phi 0.46 \pm 0.05$	$\phi 0.018$ <sup>+0.002</sup> <sub>-0.001</sub>
M	0.5	0.020

X176R-100A-1

**12. RECOMMENDED SOLDERING CONDITIONS**

The μPD70732 should be soldered and mounted under the conditions recommended in the table below.

For details of recommended soldering conditions, refer to the information document “**Semiconductor Device Mounting Technology Manual**” (C10535E).

For soldering methods and conditions other than those recommended below, contact an NEC sales representative.

**Table 12-1. Surface Mounting Type Soldering Conditions**

- (1) μPD70732GD-16-LBB : 120-pin plastic QFP (28 x 28 mm)
- μPD70732GD-20-LBB : 120-pin plastic QFP (28 x 28 mm)
- μPD70732GD-25-LBB : 120-pin plastic QFP (28 x 28 mm)

**E specification model only**

Soldering Method	Soldering Conditions	Recommended Condition Symbol
Infrared reflow	Package peak temperature: 235°C, Duration: 30 sec. Max. (at 210°C or above), Number of times: Twice Max., Time limit: 7 days <sup>Note</sup> (thereafter 36 hours prebaking required at 125°C)	IR35-367-2
VPS	Package peak temperature: 215°C, Duration: 40 sec. Max. (at 200°C or above), Number of times: Twice Max., Time limit: 7 days <sup>Note</sup> (thereafter 36 hours prebaking required at 125°C)	VP15-367-2
Wave soldering	Solder bath temperature: 260°C Max., Duration: 10 sec. Max., Number of times: Once, Time limit: 7 days <sup>Note</sup> (thereafter 36 hours prebaking required at 125°C), Preliminary heat temperature: 120°C Max. (Package surface temperature)	WS60-367-1
Partial heating	Pin temperature: 300°C Max., Duration: 3 sec. Max. (per device side)	—

**Note** For the storage period after dry-pack decapsulation, storage conditions are Max. 25°C, 65% RH.

**Caution** Use of more than one soldering method should be avoided (except for partial heating).

(2) μPD70732GC-25-9EV: 120-pin plastic TQFP (Fine pitch) (14 x 14 mm)

★

Soldering Method	Soldering Conditions	Recommended Condition Symbol
Infrared reflow	Package peak temperature: 235°C, Duration: 30 sec. Max. (at 210°C or above), Number of times: Twice Max., Time limit: 7 days <sup>Note</sup> (thereafter 10 hours prebaking required at 125°C)	IR35-107-2
VPS	Package peak temperature: 215°C, Duration: 40 sec. Max. (at 200°C or above), Number of times: Twice Max., Time limit: 7 days <sup>Note</sup> (thereafter 10 hours prebaking required at 125°C)	VP15-107-2
Partial heating	Pin temperature: 300°C Max., Duration: 3 sec. Max. (per device side)	—

**Note** For the storage period after dry-pack decapsulation, storage conditions are Max. 25°C, 65% RH.

**Caution** Use of more than one soldering method should be avoided (except for partial heating).

**Table 12-2. Insertion Type Soldering Conditions**

μPD70732R-25: 176-pin ceramic PGA (Seam weld)

Soldering Method	Soldering Conditions
Wave soldering (Pin only)	Solder bath temperature: 260°C Max., Duration: 10 sec. Max.
Partial heating	Pin temperature: 300°C Max., Duration: 3 sec. Max. (per one pin)

**Caution** Apply wave soldering only to the pins and be careful not to bring solder into direct contact with the package.

## NOTES FOR CMOS DEVICES

### ① PRECAUTION AGAINST ESD FOR SEMICONDUCTORS

**Note:** Strong electric field, when exposed to a MOS device, can cause destruction of the gate oxide and ultimately degrade the device operation. Steps must be taken to stop generation of static electricity as much as possible, and quickly dissipate it once, when it has occurred. Environmental control must be adequate. When it is dry, humidifier should be used. It is recommended to avoid using insulators that easily build static electricity. Semiconductor devices must be stored and transported in an anti-static container, static shielding bag or conductive material. All test and measurement tools including work bench and floor should be grounded. The operator should be grounded using wrist strap. Semiconductor devices must not be touched with bare hands. Similar precautions need to be taken for PW boards with semiconductor devices on it.

### ② HANDLING OF UNUSED INPUT PINS FOR CMOS

**Note:** No connection for CMOS device inputs can be cause of malfunction. If no connection is provided to the input pins, it is possible that an internal input level may be generated due to noise, etc., hence causing malfunction. CMOS devices behave differently than Bipolar or NMOS devices. Input levels of CMOS devices must be fixed high or low by using a pull-up or pull-down circuitry. Each unused pin should be connected to  $V_{DD}$  or GND with a resistor, if it is considered to have a possibility of being an output pin. All handling related to the unused pins must be judged device by device and related specifications governing the devices.

### ③ STATUS BEFORE INITIALIZATION OF MOS DEVICES

**Note:** Power-on does not necessarily define initial status of MOS device. Production process of MOS does not define the initial operation status of the device. Immediately after the power source is turned ON, the devices with reset function have not yet been initialized. Hence, power-on does not guarantee out-pin levels, I/O settings or contents of registers. Device is not initialized until the reset signal is received. Reset operation must be executed immediately after power-on for devices having reset function.



## Regional Information

Some information contained in this document may vary from country to country. Before using any NEC product in your application, please contact the NEC office in your country to obtain a list of authorized representatives and distributors. They will verify:

- Device availability
- Ordering information
- Product release schedule
- Availability of related technical literature
- Development environment specifications (for example, specifications for third-party tools and components, host computers, power plugs, AC supply voltages, and so forth)
- Network requirements

In addition, trademarks, registered trademarks, export restrictions, and other legal issues may also vary from country to country.

### **NEC Electronics Inc. (U.S.)**

Mountain View, California  
Tel: 800-366-9782  
Fax: 800-729-9288

### **NEC Electronics (Germany) GmbH**

Duesseldorf, Germany  
Tel: 0211-65 03 02  
Fax: 0211-65 03 490

### **NEC Electronics (UK) Ltd.**

Milton Keynes, UK  
Tel: 01908-691-133  
Fax: 01908-670-290

### **NEC Electronics Italiana s.r.l.**

Milano, Italy  
Tel: 02-66 75 41  
Fax: 02-66 75 42 99

### **NEC Electronics (Germany) GmbH**

Benelux Office  
Eindhoven, The Netherlands  
Tel: 040-2445845  
Fax: 040-2444580

### **NEC Electronics (France) S.A.**

France  
Tel: 01-30-67 58 00  
Fax: 01-30-67 58 99

### **NEC Electronics (France) S.A.**

Spain Office  
Madrid, Spain  
Tel: 01-504-2787  
Fax: 01-504-2860

### **NEC Electronics (Germany) GmbH**

Scandinavia Office  
Taeby Sweden  
Tel: 8-63 80 820  
Fax: 8-63 80 388

### **NEC Electronics Hong Kong Ltd.**

Hong Kong  
Tel: 2886-9318  
Fax: 2886-9022/9044

### **NEC Electronics Hong Kong Ltd.**

Seoul Branch  
Seoul, Korea  
Tel: 02-528-0303  
Fax: 02-528-4411

### **NEC Electronics Singapore Pte. Ltd.**

United Square, Singapore 1130  
Tel: 253-8311  
Fax: 250-3583

### **NEC Electronics Taiwan Ltd.**

Taipei, Taiwan  
Tel: 02-719-2377  
Fax: 02-719-5951

### **NEC do Brasil S.A.**

Sao Paulo-SP, Brasil  
Tel: 011-889-1680  
Fax: 011-889-1689

**Reference:** Electrical Characteristics for Microcomputer (IEI-601)

The related documents indicated in this publication may include preliminary versions. However, preliminary versions are not marked as such.

**V805, V810, and V810 Family are trademarks of NEC Corporation.**

No part of this document may be copied or reproduced in any form or by any means without the prior written consent of NEC Corporation. NEC Corporation assumes no responsibility for any errors which may appear in this document.

NEC Corporation does not assume any liability for infringement of patents, copyrights or other intellectual property rights of third parties by or arising from use of a device described herein or any other liability arising from use of such device. No license, either express, implied or otherwise, is granted under any patents, copyrights or other intellectual property rights of NEC Corporation or others.

While NEC Corporation has been making continuous effort to enhance the reliability of its semiconductor devices, the possibility of defects cannot be eliminated entirely. To minimize risks of damage or injury to persons or property arising from a defect in an NEC semiconductor device, customers must incorporate sufficient safety measures in its design, such as redundancy, fire-containment, and anti-failure features.

NEC devices are classified into the following three quality grades:

"Standard", "Special", and "Specific". The Specific quality grade applies only to devices developed based on a customer designated "quality assurance program" for a specific application. The recommended applications of a device depend on its quality grade, as indicated below. Customers must check the quality grade of each device before using it in a particular application.

Standard: Computers, office equipment, communications equipment, test and measurement equipment, audio and visual equipment, home electronic appliances, machine tools, personal electronic equipment and industrial robots

Special: Transportation equipment (automobiles, trains, ships, etc.), traffic control systems, anti-disaster systems, anti-crime systems, safety equipment and medical equipment (not specifically designed for life support)

Specific: Aircrafts, aerospace equipment, submersible repeaters, nuclear reactor control systems, life support systems or medical equipment for life support, etc.

The quality grade of NEC devices is "Standard" unless otherwise specified in NEC's Data Sheets or Data Books. If customers intend to use NEC devices for applications other than those specified for Standard quality grade, they should contact an NEC sales representative in advance.

Anti-radioactive design is not implemented in this product.